

be  
**SMART**  
use

 **Kubala**<sup>®</sup>

Building  
tools  
catalogue  
**2024**



# 1

## BUILDING TOOLS

STYROPOR FLOATS	8
PLASTIC FLOATS	9
SPONGE	17
ABRASIVE FLOATS AND TOOLS	18
STAINLESS STEEL TROWELS	23
FINISHING TOOLS	34
SPATULAS	38
MASONRY TROWELS	46
SCRAPERS	54
TOOLS FOR CELLULAR CONCRETE	57
STIRRERS	59
CONTAINERS	63
VENTING SPIKED ROLLER	67
OTHER TOOLS	68
GLAZING TOOLS SMART	73
ECO LINE	76

# 2

## PAINTING TOOLS

PAINTBRUSHES	82
PAINT ROLLERS	86
PAINT ACCESSORIES	91
PROTECTIVE FOIL	94

# 3

## EXPOSITION SYSTEMS

EXPOSITION SYSTEMS	97
--------------------	----



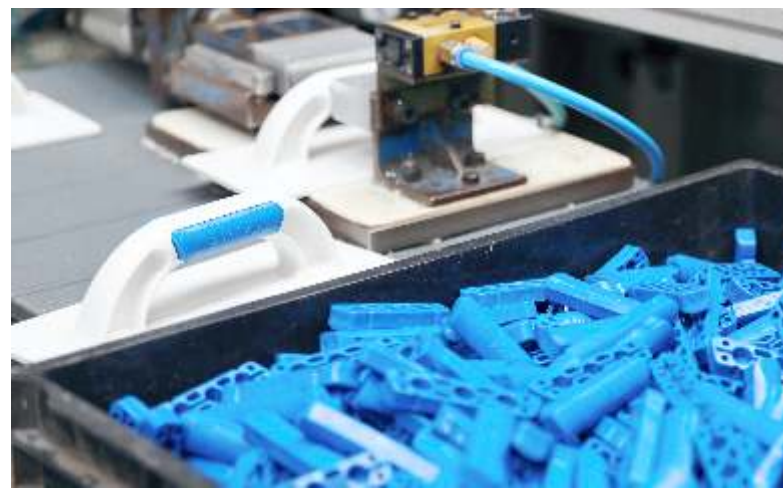



## About us

We have been **operating** since 1987, when Roman Kubala, the chairman of Kubala, produced the first manual construction tools under the Kubala brand.

We **are** a family company, the winner of the Forbes Most Valuable Family Companies ranking for those who increase their value and at the same time "do it in an honest and transparent manner".

We **design** manual construction tools with the comfort, safety, and convenience of the Contractors in mind. We are the authors of 3 inventions, 2 trademarks, 10 industrial designs, 13 utility models, and 46 Community designs.

We **manufacture** tools in Ustroń in an assortment of over 700 products and deliver them to Contractors in Europe, North America, Africa, Australia, and Asia.

We **introduce** the best available technical and technological solutions by investing in educating our employees, modern machinery and improving the quality control system of our products.

We **know** how valuable the Contractors' time is and how important the quality of their work is. The result of these elements is economic success, which gives the Contractor the basis for a peaceful and happy life. That is why, in our tools, we use the best solutions and materials that guarantee quality, durability, ergonomics and work precision.

We **focus** on the needs of the Contractors, which is why we test tools together with them before introducing them for sale. We make sure that the Contractors receive tools that meet the rapid changes in finishing technology and construction chemicals as well as the high expectations of investors.

We **meet** the Contractors in person during workshops, presentations and tests organized by our traders and instructors. Our company's sales department consists of real people, happy to answer any Contractors' questions in person, by phone and e-mail.

We **communicate** with contractors in the virtual space through the website and social media. We use our own sales platforms, distributors, and commercial network to save the Contractor's time as much as possible.

We **dare** to use the Contractors' knowledge and experience. We respect their opinions and take their views into account. We are constantly in dialogue with Contractors during workshops as part of our original Kubala MasterClass project, where we all exchange knowledge and experience.

We **achieve** success because we work diligently every day to earn and enjoy the trust of our Contractors.

 **Kubala**<sup>®</sup>



1

 Kruppa  
Kruppa

BUILDING  
TOOLS

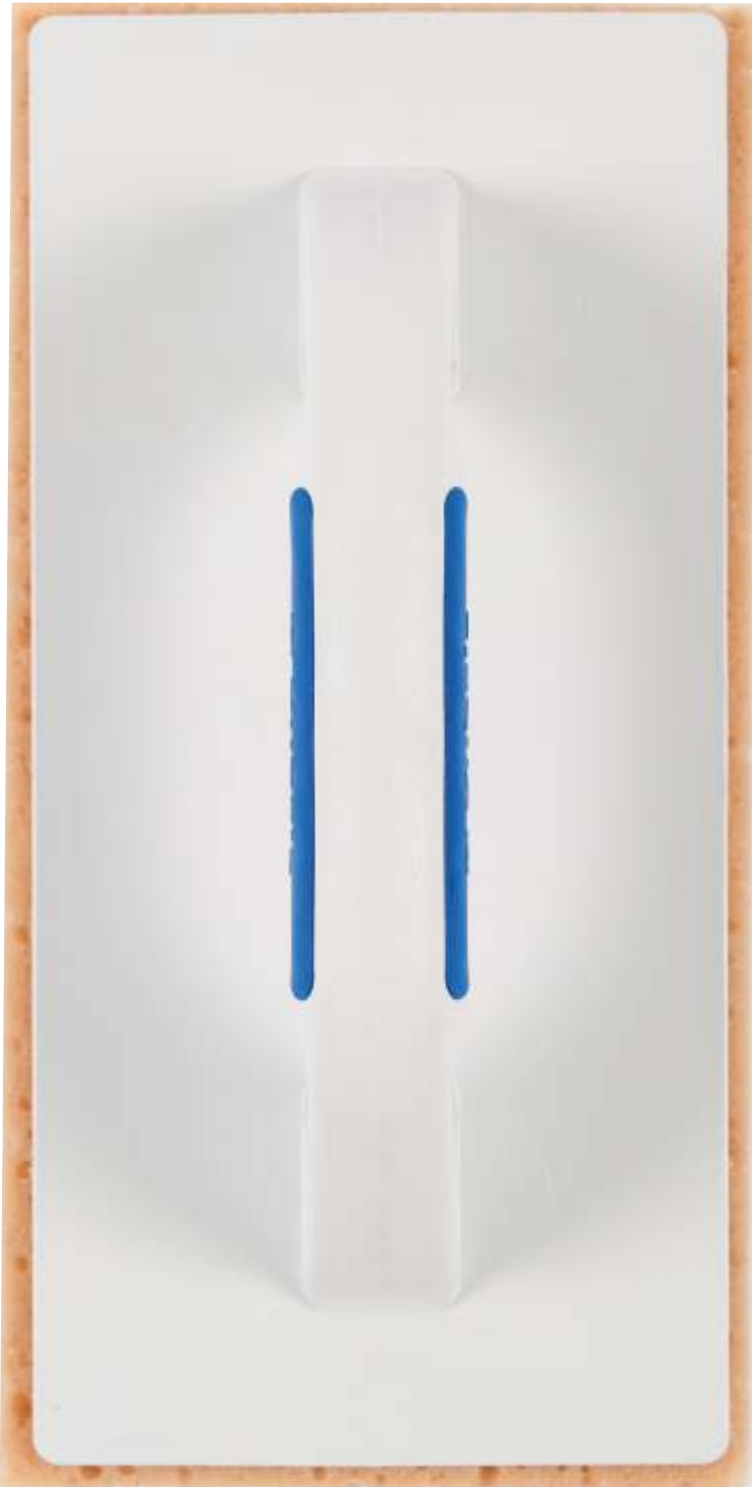

## STYROPOR FLOATS / PLASTIC FLOATS



### Styropor float

Paca tynkarska, Styropor Reibebrett

Hard styropor, bulk value after foaming: 200g/l, guarantees high durability and float's resistance to wearing. For plastering.

no.	dimensions	pcs.	ean
0101	140x260mm	1/10	
0102	140x500mm	1/5	
0103	140x700mm	1/5	
0104	140x1000mm	1/5	
0105	180x320mm	1/10	



### Styropor conic float

Paca tynkarska, stożkowa, Styropor Fummelbrett "Spitz"

Hard styropor, bulk value after foaming: 200g/l, guarantees high durability and float's resistance to wearing. For plastering in hard accessible places.

no.	dimensions	pcs.	ean
0107	180x320mm	1/10	



PS



### Plastic float, conic

Paca z tworzywa, stożkowa, Reibebrett für Kalkputz, "Spitz"

Plastic: PS.

Plate thickness: 2mm.

For decorative plastering of interiors.

no.	dimensions	pcs.	ean
0380	70x230mm	1/10	



N



### Stainless steel spatula for decorative effects

Szpachla do dekoracji, Allzweck Spachtel

The entire tool is made of stainless acid-resistant steel. The spatula is designed for applying decorative masses and other finishing works.

no.	dimensions	pcs.	ean
1626	150mm	1/10	

### Brush for decoration

#### Szczotka do dekoracji, Paddel Pinsel

The handle is made of beech wood, natural with FSC certification. The working part is made of PET fiber. The brush is designed for creating decorative patterns and outlines when working with decorative masses. The special arrangement of the bristles facilitates achieving a precise effect on the surface..



no.	dimensions	pcs.	ean
1649	160mm	1/10	



### Plastic float, smooth

#### Paca z tworzywa do tynków, Reibebrett, Kunststoff, glatt

Plastic: ABS – increased hardness of the working part.  
Ergonomic, shaped and balanced handle.  
Plate thickness: 3mm.  
Ergonomic, shaped and balanced handle.  
For smoothing and structuring of plasters.



no.	dimensions	pcs.	ean
0300	130x270mm	1/12	



### Plastic float, smooth

#### Paca z tworzywa do tynków, Reibebrett, Kunststoff, glatt

Plastic: ABS - increased hardness of the working part.  
Ergonomic and profiled 2K soft handle.  
Plate thickness: 3mm.  
For smoothing and structuring of plasters.



no.	dimensions	pcs.	ean
0375	130x270mm	1/12	



### Plastic float, smooth

#### Paca z tworzywa do tynków, Reibebrett, Kunststoff, glatt

Plastic: PS.  
Perfectly even working part of the trowel thanks to ultrasonic welding of the handle to the plate.  
The float does not scratch the rubbed surface thanks to the rounded edges.  
Ergonomic, shaped and balanced handle.  
Plate thickness: 3mm.  
For smoothing and structuring of plasters.



no.	dimensions	pcs.	ean
0301	130x270mm	1/12	





## PLASTIC FLOATS



### Plastic float, smooth

Paca z tworzywa do tynków, Reibebrett, Kunststoff, glatt  
 Plastic: PS - polystyrene.  
 Ergonomic, shaped and balanced handle.  
 Plate thickness: 3mm.  
 For smoothing and structuring of plasters.

no.	dimensions	pcs.	ean
0355	130x270mm	1/12	



### Pointing float

Paca do spoinowania, Reibebrett, Kunststoff, Gummibelag  
 Pointing float, cut at sides in different angles for more  
 precise joint filling in hard accessible places.  
 For pointing with cement and epoxy joints.

no.	dimensions	pcs.	ean
0325	95x240mm	1/5	



### Rubber stripping knife

Szpachla gumowa, Fugengummi  
 Plastic.  
 Rubber cut at sides for the more precise  
 joint filling in hard accessible places.  
 For pointing with cement and epoxy welds.

no.	dimensions	pcs.	ean
0611	145mm	1/10	
0612	245mm	1/10	



### Pointing float

Paca do spoinowania, Reibebrett, Kunststoff, Gummibelag  
 Plastic.  
 Ergonomic and profiled 2K soft grip.  
 Float, cut at sides in different angles for more  
 precise joint filling in hard accessible places.  
 Two rounded corners.  
 For pointing with cement and epoxy joints.

no.	dimensions	pcs.	ean
0370	95x240mm	1/5	

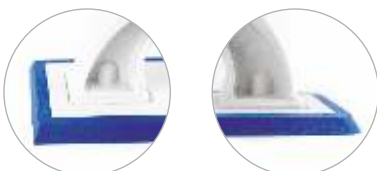



## PLASTIC FLOATS



### Plastic float with white rubber

Paca z tworzywa z gumą białą, Reibebrett, Kunststoff, Gummibelag  
Plastic: ABS.

Ergonomic and profiled 2K soft handle.

Pad: white rubber, thickness: 8mm.

For pointing.

no.	dimensions	pcs.	ean
0383	140x280mm	1/12	



### Plastic float with black rubber

Paca z tworzywa z gumą czarną, Reibebrett, Kunststoff, Gummibelag  
Plastic: ABS.

Ergonomic and profiled 2K soft handle.

Pad: Black rubber (does not crush, does not dirty the joint),  
thickness: 7mm.

For pointing with a cement grout.

no.	dimensions	pcs.	ean
0374	140x280mm	1/12	



### Plastic float with felt

Paca z tworzywa z filcem, Reibebrett, Kunststoff, Filzbelag  
Plastic: ABS.

Ergonomic and profiled 2K soft handle.

Pad polishing felt (does not delaminate, does not swell),  
thickness: 6mm.

For smoothing of plasters.

no.	dimensions	pcs.	ean
0382	140x280mm	1/12	



### Plastic float with rubber sponge

Paca z tworzywa z gąbką gumową, Reibebrett, Schwammauflage  
Plastic: ABS.

Ergonomic and profiled 2K soft handle.

Base rubber sponge, natural rubber, thickness 20 mm.

For smoothing wet gypsum plasters.

no.	dimensions	pcs.	ean
0386	140x280mm	1/12	

### Plastic float with rubber hard sponge

Paca z gąbką gumową twardą, Reibebrett mit Gummischwamm

Plastic: ABS.

Ergonomic and profiled 2K soft handle.

Pad hard rubber sponge, thickness: 20mm.

For smoothing of cement and lime plasters.

no.	dimensions	pcs.	ean
0397	140x280mm	1/12	



### Plastic float with duren

Paca z durenem, Reibebrett mit Durol-Einlage

Plastic: ABS.

Ergonomic and profiled 2K soft handle.

Pad duren: thickness: 20mm. In contrast to rubber sponges, duren absorbs and slowly releases water during the smoothing.

For smoothing of cement and lime plasters.

no.	dimensions	pcs.	ean
0399	140x280mm	1/12	



### Articulated aluminium float with rubber sponge

Paca aluminiowa przegubowa z gąbką, Alugelenkreibebrett, Egalisette

Plate made of aluminium with handle for telescopic stick installation.

Pad natural rubber sponge, thickness: 20mm.

For smoothing of wet gypsum plasters.

no.	dimensions	pcs.	ean
0331	200x400mm	1/5	
0332	140x280mm	1/10	
1600	200x400mm, float pad	1/20	

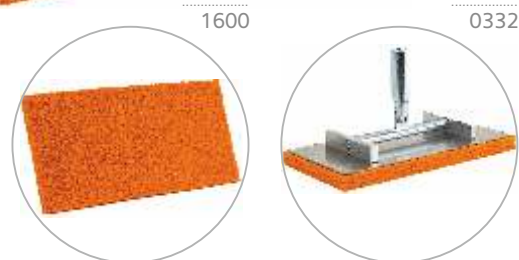

### Float with black and white fabric

Paca z białą i czarną włókniną, Reibebrett, mit Schwarz- und Weißfaser

Plastic: ABS.

Ergonomic and profiled 2K soft handle.

Non woven fabric attached with Velcro, for cleaning and polishing of ceramic tiles, after epoxy weld pointing.

Complete set: Float, black fabric – hard and white – soft (0360).

Complete set: black fabric – hard and white – soft (0361).

Complete set: 2 x white fabric - soft (0362).

Complete set: 2 x black fabric - hard (0363).

no.	dimenstions	pcs.	ean
0360	120x250mm	1/6	
0361	120x250mm	1/5	
0362	120x250mm	1/5	
0363	120x250mm	1/5	





## PLASTIC FLOATS



### Plastic float with cellulose sponge

Paca z tworzywa z gąbką celulozową, Reibebrett, Celluloseschwamm  
Plastic: ABS.

Ergonomic and profiled 2K soft handle. It does not react with epoxy joint components, it does not cause joint discoloration.

Pad cellulose sponge, thickness: 28mm.

For perfect cleaning and shaping of both cement and epoxy joint fillers.

no.	dimensions	pcs.	ean
0377	140x280mm	1/12	

For perfect cleaning and shaping of both cement and epoxy joint fillers.  
High quality.

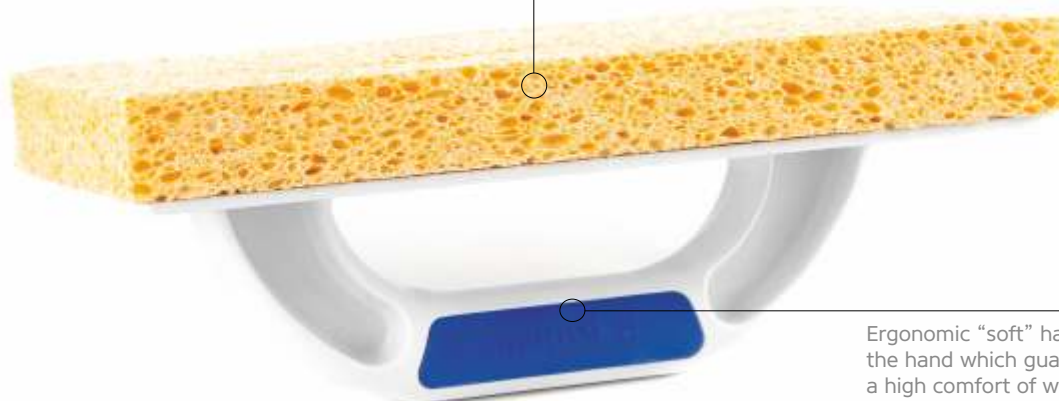

Ergonomic "soft" handle, perfectly fits the hand which guarantees a high comfort of work.



### Plastic float with dense sponge with pores

Paca z gąbką porową gęstą, Reibebrett mit Schwamm, Kunststoff  
Plastic: ABS.

Ergonomic and profiled 2K soft handle.

Pad dense sponge with pores, thickness: 30mm.

For cleaning of tiles after pointing.

no.	dimensions	pcs.	ean
0389	140x280mm	1/12	



### Plastic float with truncated edge

Paca z gąbką ze ściętym bokiem, Reibebrett, Kunststoff, Schwammauflage  
Plastic: ABS.

Ergonomic and profiled 2K soft handle.

Pad dense sponge with the longer edge truncated, thickness: 40mm.

For cleaning of tiles after pointing, does not leave streaks on the cleaned surface.

no.	dimensions	pcs.	ean
0350	130x290mm	1/12	



### Plastic float with incised sponge

Paca z tworzywa z gąbką nacinaną, Reibebrett, Hydroschwammauflage

Plastic: ABS.

Ergonomic and profiled 2K soft handle.

Pad sponge with pores, dense, incised, thickness: 30mm.

For cleaning of tiles after pointing. Thanks to incisions it collects dirt from cleaned surface more easily. It is recommended to press the float against rollers of the glazing bucket to drain out the water.

For cleaning of tiles after pointing.

no.	dimensions	pcs.	ean
0387	140x280mm	1/12	



### Plastic float with absorbing, incised sponge

Paca z gąbką hydrochłonną nacinaną, Reibebrett, Hydroschwammauflage

Plastic: ABS.

Ergonomic and profiled 2K soft handle.

Pad sweepex absorbing sponge, thickness: 30mm.

Thanks to the incisions it collects dirt from the cleaned surface faster. It is recommended to press the trowel on rolls from the glazing bucket for cleaning of plates after pointing.

no.	dimensions	pcs.	ean
0378	140x280mm	1/12	



## Plastic float with absorbing, incised sponge

Thanks to incisions it collects dirt from cleaned surface more easily



## PLASTIC FLOATS



### Plastic float with coarse sponge

Paca z tworzywa z gąbką rzadką, Reibebrett, Kunststoff, Schwammauflage  
Plastic: ABS.

Ergonomic and profiled 2K soft grip.  
Pad coarse sponge, thickness: 20mm.  
For cleaning of tiles after pointing.

no.	dimensions	pcs.	ean
0385	140x280mm	1/12	



### Plastic float with dense sponge

Paca z tworzywa z gąbką, Reibebrett, Kunststoff, Schwammauflage  
Plastic: ABS.

Ergonomic and profiled 2K soft grip.  
Pad dense sponge, thickness: 20mm.  
For cleaning of plates after pointing.

no.	dimensions	pcs.	ean
0384	140x280mm	1/12	



### Plastic float with sparse sponge with pores

Paca z tworzywa z gąbką porową, Reibebrett, Kunststoff, Schwammauflage  
Plastic: ABS.

Ergonomic and profiled 2K soft handle.  
Pad sponge with combined pores, thickness: 30mm.  
The combined pores guarantee increased sponge absorbability  
and better water release during pressing against rollers.  
For cleaning of tiles after pointing.

no.	dimensions	pcs.	ean
0379	140x280mm	1/12	



### Plastic float with absorbing sponge

Paca z gąbką hydrochłoną, Reibebrett, Hydroschwammauflage  
Plastic: ABS.

Ergonomic and profiled 2K soft grip.  
Pad sweepex absorbing sponge, thickness: 30mm.  
The combined pores guarantee increased absorbability of the sponge  
and better water release during pressing against the rollers.  
For cleaning of tiles after pointing.

no.	dimensions	pcs.	ean
0388	140x280mm	1/12	



## Plastic float with pad

Paca z tworzywa z podkładem, Reibebrett, Kunststoff  
Plastic: PS.

Ergonomic and shaped handle.

Pad: white rubber, 8mm (0310), black rubber, 7mm (0320), polishing felt, 6mm (0309), coarse sponge, 20mm (0312), dense sponge, 20mm (0311), dense sponge with pores, incised, 30mm (0324), rubber sponge, 20mm (0313).

no.	dimensions	pcs.	ean
0310	140x280mm	1/12	
0320	140x280mm	1/12	
0309	140x280mm	1/12	
0312	140x280mm	1/12	
0311	140x280mm	1/12	
0324	140x280mm	1/12	
0313	140x280mm	1/12	



0320



0310



0312



0311

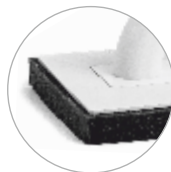

0324



0309



## Glazing sponge

Gąbka glazurnicza, Fliesenleger Handschwamm  
Dense sponge (1680).

Absorbing sponge sweepex (1683).

Combined pores guarantee sponge's increased absorbability and better water release.

Dense sponge with pores (1684).

Hard sponge with combined pores (1689).

Combined pores guarantee sponge's increased absorbability and better water release.

For washing tiles after pointing.

Absorbing sponge sweepex MASTER (1692).

The material is soft and delicate. The sponge structure ensures better absorbency and water drainage.

It cleans and shapes cement grouts, providing significant smoothing of the joint. The sponge is infused with an agent to prevent the growth of bacteria and fungi.

Used for washing tiles after grouting.



no.	dimensions	pcs.	ean
1680	110x160x60mm	1/20	
1683	110x160x60mm	1/20	
1684	110x160x60mm	1/20	
1689	110x160x60mm	1/20	
1692	110x160x60mm	1/20	

1683



1684



1689



**N** 1692





## SPONGE / ABRASIVE TOOLS



### Cellulose sponge

Gąbka celulozowa, Celluloseschwamm

Ergonomic and reusable. High quality.  
For perfect cleaning and shaping of both  
cement and epoxy joint fillers.

no.	dimensions	pcs.	ean
1690	110x180x51mm	1/20	
1691	110x180x36mm	1/20	



### Abrasive sponge

Gąbka ścierna, Schleifschwamm

For smoothing of gypsum surfaces.

no.	dimensions	pcs.	ean
9951	70x100x25mm gran. 40	1/12	
9952	70x100x25mm gran. 60	1/12	
9953	70x100x25mm gran. 80	1/12	
9954	70x100x25mm gran. 100	1/12	
9955	70x100x25mm gran. 120	1/12	
9956	70x100x25mm gran. 150	1/12	
9957	70x100x25mm gran. 180	1/12	
9958	70x100x25mm gran. 220	1/12	



### Abrasive sponge

Gąbka ścierna, Schleifschwamm

For smoothing of gypsum surfaces.

no.	dimensions	pcs.	ean
9961	58/83x100x25mm gran. 40	1/12	
9962	58/83x100x25mm gran. 120	1/12	
9963	58/83x100x25mm gran. 220	1/12	
9964	58/83x100x25mm gran. 60	1/12	
9965	58/83x100x25mm gran. 100	1/12	
9966	58/83x100x25mm gran. 150	1/12	
9967	58/83x100x25mm gran. 180	1/12	



### Abrasive grid

Siatka szlifierska, Ersatzschleifgitter

For abrasive floats. Usage: smoothing of gypsum surfaces.

no.	dimensions	pcs.	ean
1675	105x280mm gran. 60	1set=5 pcs	
1676	105x280mm gran. 80	1set=5 pcs	
1677	105x280mm gran. 100	1set=5 pcs	
1678	105x280mm gran. 120	1set=5 pcs	
1679	105x280mm gran. 150	1set=5 pcs	
1681	105x280mm gran. 180	1set=5 pcs	
1682	105x280mm gran. 200	1set=5 pcs	

## Abrasive float MASTER LINE

Paca szlifierska, Handschleifer

Plastic: PS.

Ergonomic, shaped 3k soft handle.

Abrasive mesh or abrasive paper installed with wing bolts.

Abrasive paper (1616). For levelling of surfaces during thermal insulation works, including mineral wool.

no.	dimensions	pcs.	ean
0322	200x495mm	1/10	
1616	200x600mm	1/10	

**Kubala®**  
MASTER LINE



1616



## Abrasive float

Paca szlifierska, Handschleifer

Plastic: PS.

Ergonomic and shaped handle.

Rubber pad thickness: 3mm.

Abrasive grid or abrasive paper installed with wing bolts.

For smoothing of gypsum surfaces.

no.	dimensions	pcs.	ean
0326	105x210mm	1/20	



## Abrasive float

Paca szlifierska, Handschleifer

Plastic: PS.

Ergonomic handle.

Rubber pad thickness: 3mm.

Abrasive grid installed with clamps.

For smoothing of gypsum surfaces.

no.	dimensions	pcs.	ean
0306	105x210mm	1/20	



## Abrasive float 'rasp-type'

Paca szlifierska "tarnik", Handschleifer zum Anrauen

Plastic: PS.

Ergonomic and shaped handle.

Working part made of galvanised, perforated plate.

For levelling of styropor boards during thermal insulation works.

no.	dimensions	pcs.	ean
0321	180x400mm	1/10	



## ABRASIVE FLOATS

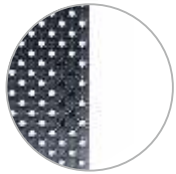

**Kubala®**  
MASTER LINE

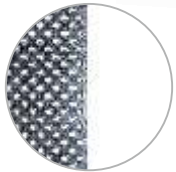

**Kubala®**  
MASTER LINE

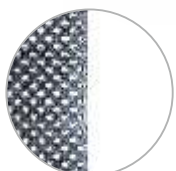

### Abrasive float 'rasp-type'

Paca szlifierska "tarnik" przelotowa, Handschleifer zum Anrauen

The whole tool made of plastic PS.

Ergonomic, shaped 2k soft handle handle.

The straight-through plate guarantees easy cleaning and longer durability of the tool.

For thermal insulation works, including styropor boards.

no.	dimensions	pcs.	ean
0341	165x365mm	1/10	

### Abrasive float 'rasp-type' MASTER LINE

Paca szlifierska "tarnik", Handschleifer zum Anrauen

Plastic PS - polystyrene. Working part made of galvanised, perforated plate. Hydraulically clamped float.

Ergonomic, shaped 3k soft handle handle.

The straight-through plate guarantees easy cleaning and longer durability of the tool. For levelling of styropor boards.

no.	dimensions	pcs.	ean
0344	130x270mm	1/20	
0343	160x380mm	1/10	
0345	180x400mm	1/10	

### Abrasive float 'rasp-type'

Paca szlifierska "tarnik", Handschleifer zum Anrauen

Plastic: PS (0340), ABS (0335).

Ergonomic, shaped 2k soft handle.

Working part made of galvanised, perforated plate.

For levelling of styropor boards during thermal insulation works.

no.	dimensions	pcs.	ean
0335	130x270mm	1/20	
0340	160x380mm	1/10	

### Abrasive float 'rasp-type'

Paca szlifierska "tarnik" przelotowa, Handschleifer zum Anrauen

Plastic: PS. Working part made of galvanised, perforated plate.

Ergonomic, shaped, 2k soft handle.

The perforated plate is in line with holes of the working part, what guarantees easy cleaning and longer durability of the tool.

For thermal insulation works, including styropor boards.

no.	dimensions	pcs.	ean
0342	160x380mm	1/10	

# Abrasive float 'rasp-type' MASTER LINE, 0346



**MADE IN POLAND**  
Polish manufacturer from 1987



**THREE-COMPONENT HANDLE**  
Ensuring the highest comfort of work



**QUALITY GUARANTEE**  
Blades perfectly prepared to work with the material



**REGISTERED DESIGN**  
Submitted to the Polish Patent Office under the number W.127633



**WORKING PART THICKNESS**  
The use of thicker sheet metal extends the durability and rigidity of the working part



**STRAIGHT-THROUGH**  
Lack of a plastic plate causes increased throughput



**WEIGHT**  
Reduced weight of the product



## Abrasive float 'rasp-type' MASTER LINE

Paca szlifierska "tarnik" przelotowa, Handschleifer zum Anrauen  
Working part of the rasp is made of 1mm thick galvanized steel.  
Lack of a plastic plate causes increased throughput.  
Reduced weight of the product is aimed at reducing the end-users workload during long hours of work.  
Ergonomic, 3k soft handle fits perfectly in the hand, ensuring the highest comfort of work.  
Tool does not rotate in hand, even when working in a glove.

**Kubala®**  
MASTER LINE



no.	dimensions	pcs.	ean
0346	160x360mm	1/10	







### Stainless steel trowel

Paca nierdzewna, Glättkelle, Edelstahl,

Ergonomic, balanced and shaped handle made of PS.

Stainless, acid resistant steel, thickness: 0,7mm.

For application of gypsum plaster, mortars and adhesives (0401).

Stainless steel trowel, notched (0402, 0403, 0404, 0405, 0406).

For distribution of adhesive mortars.

no.	dimensions	pcs.	ean
0401	130x270mm, smooth	1/10	5 907798 020401
0402	130x270mm, notch 4x4	1/10	5 907798 020402
0403	130x270mm, notch 6x6	1/10	5 907798 020403
0404	130x270mm, notch 8x8	1/10	5 907798 020404
0405	130x270mm, notch 10x10	1/10	5 907798 020405
0406	130x270mm, notch 12x12	1/10	5 907798 020406



0402  
0403  
0404  
0405  
0406

### Stainless steel trowel

Paca nierdzewna, Glättkelle, Edelstahl,

Ergonomic, balanced and shaped handle made of beech wood, varnished, jacking foot made by polyamide with fiberglass.

Stainless, acid resistant steel, thickness: 0,7mm.

For application of gypsum plaster, mortars and adhesives (0414).

Stainless steel trowel, notched (0414, 0416, 0417, 0418, 0419).

For distribution of adhesive mortars.

no.	dimensions	pcs.	ean
0414	130x270mm, smooth	1/10	5 907798 020414
0415	130x270mm, notch 4x4	1/10	5 907798 020415
0416	130x270mm, notch 6x6	1/10	5 907798 020416
0417	130x270mm, notch 8x8	1/10	5 907798 020417
0418	130x270mm, notch 10x10	1/10	5 907798 020418
0419	130x270mm, notch 12x12	1/10	5 907798 020419



0415  
0416  
0417  
0418  
0419

### Stainless steel trowel

Paca nierdzewna, Glättkelle, Edelstahl,

Ergonomic, balanced, shaped, 2k soft handle on jacking foot made by polyamide with fiberglass.

Stainless, acid resistant steel, thickness: 0,7mm.

For application of gypsum plaster, mortars and adhesives (0473).

Stainless steel trowel, notched (0201, 0202, 0203, 0204, 0205).

For distribution of adhesive mortars.

no.	dimensions	pcs.	ean
0473	130x270mm, smooth	1/10	5 907798 020473
0201	130x270mm, notch 4x4	1/10	5 907798 020201
0202	130x270mm, notch 6x6	1/10	5 907798 020202
0203	130x270mm, notch 8x8	1/10	5 907798 020203
0204	130x270mm, notch 10x10	1/10	5 907798 020204
0205	130x270mm, notch 12x12	1/10	5 907798 020205



0201  
0202  
0203  
0204  
0205

### Stainless steel trowel

Paca nierdzewna, Glättkelle, Edelstahl

Ergonomic, balanced, shaped, 2k soft handle

on jacking foot made by polyamide with fiberglass.

Stainless, acid resistant steel, thickness: 0,7mm.

For application of gypsum plaster, mortars and adhesives (0240).

Stainless steel trowel, notched (0241, 0242, 0243, 0244, 0245).

For distribution of adhesive mortars.

no.	dimensions	pcs.	ean
0240	130x270mm, smooth	1/10	5 907798 020240
0241	130x270mm, notch 4x4	1/10	5 907798 020241
0242	130x270mm, notch 6x6	1/10	5 907798 020242
0243	130x270mm, notch 8x8	1/10	5 907798 020243
0244	130x270mm, notch 10x10	1/10	5 907798 020244
0245	130x270mm, notch 12x12	1/10	5 907798 020245



0241  
0242  
0243  
0244  
0245

## STAINLESS STEEL TROWELS



### Stainless steel trowel with rounded edges

Paca nierdzewna, Glättkelle, Edelstahl, glatt  
Ergonomic, balanced, shaped 2k soft handle on jacking foot made by polyamide with fiberglass. Stainless, acid resistant steel, thickness: 0,7mm. For application of gypsum plaster, thanks to two rounded edges it leaves less visible marks.

no.	dimensions	pcs.	ean
0206	130x270mm	1/10	



### Stainless steel trowel with half-round notches

Paca nierdzewna, Zahnekelle, Edelstahl-Zahnung  
Ergonomic, balanced, shaped 2k soft handle on jacking foot made by polyamide with fiberglass. Stainless, acid resistant steel, thickness: 0,7mm. For distribution of self-levelling, thick-layered and formable adhesives on large format tiles. Guarantees maximum tile covering with the adhesive.

no.	dimensions	pcs.	ean
0463	130x270mm, notch15x20	1/10	

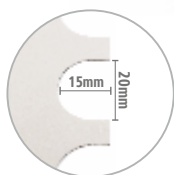

### Stainless steel trowel with skewed notch

Paca nierdzewna, Zahnekelle, Edelstahl-Zahnung  
Ergonomic, balanced, shaped 2k soft handle on jacking foot made by polyamide with fiberglass. Stainless, acid resistant steel, thickness: 0,7mm. For distribution of adhesive mortars, using method of spring fixing of glaze tiles. Guarantees maximum tile covering with the adhesive.

no.	dimensions	pcs.	ean
0487	130x270mm, notch 8	1/10	



Choose  
your  
shape.

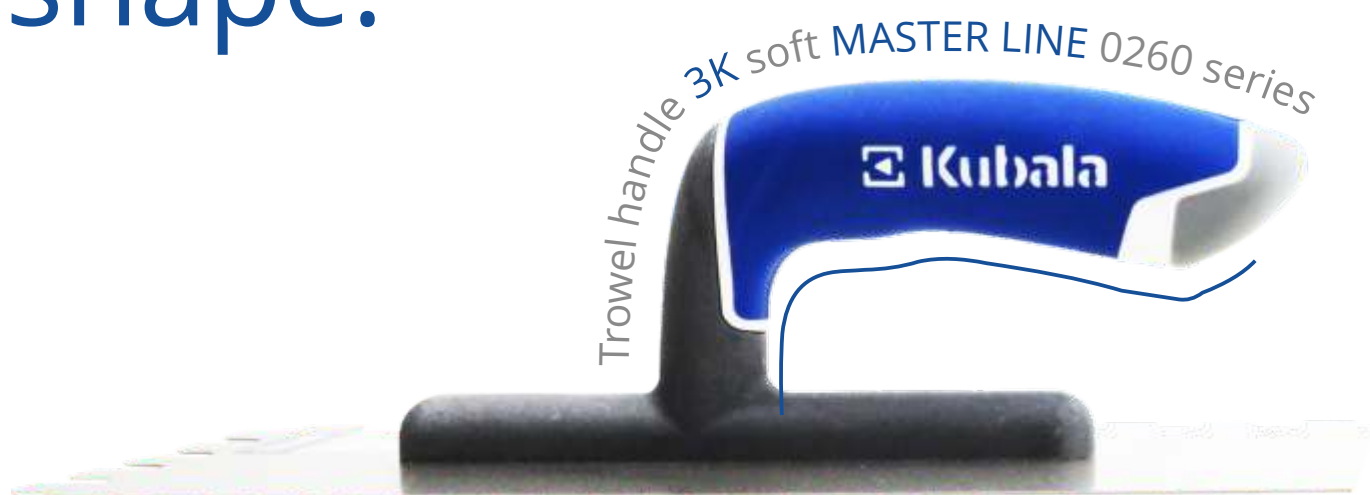

or

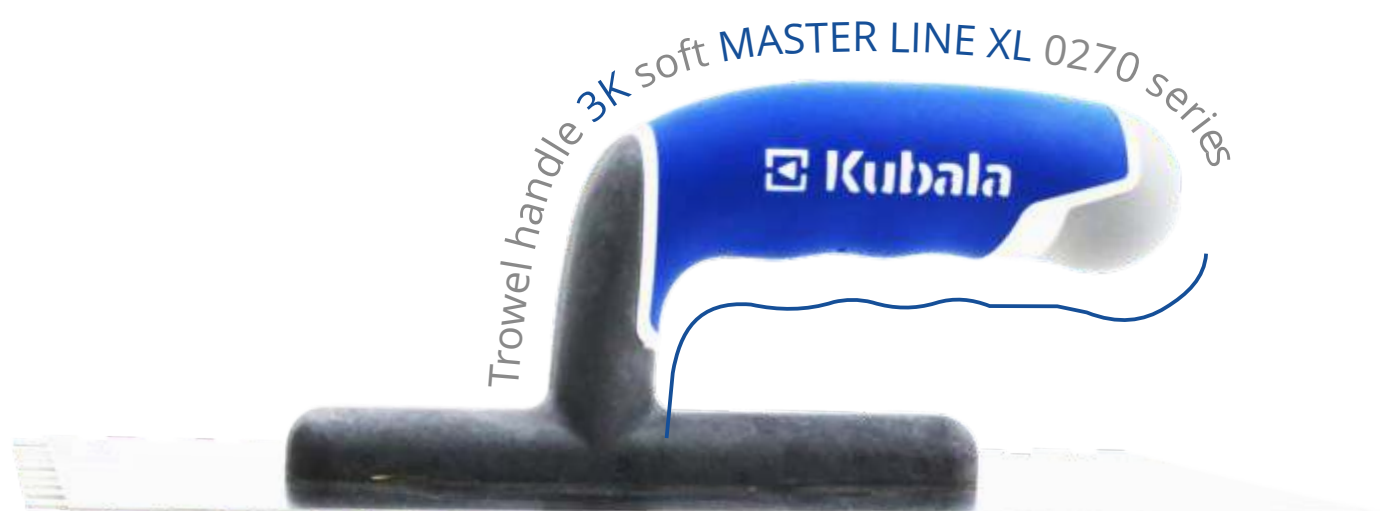



## STAINLESS STEEL TROWELS MASTER LINE series



0271  
0272  
0273  
0274  
0275



### Smooth stainless steel trowel MASTER LINE XL

Paca nierdzewna, gładka, Glättkelle, Edelstahl, glatt  
Ergonomic, balanced, shaped, 3k soft handle  
on jacking foot made by polyamide with fiberglass.  
Stainless, acid resistant steel, thickness: 0,7mm.

For application of gypsum plaster, mortars and adhesives (0270).  
Stainless steel trowel, notched (0271, 0272, 0273, 0274, 0275).  
For distribution of adhesive mortars.

no.	dimensions	pcs.	ean
0270	130x270mm	1/10	5 909202 027000
0271	130x270mm, notch 4x4	1/10	5 909202 027100
0272	130x270mm, notch 6x6	1/10	5 909202 027200
0273	130x270mm, notch 8x8	1/10	5 909202 027300
0274	130x270mm, notch 10x10	1/10	5 909202 027400
0275	130x270mm, notch 12x12	1/10	5 909202 027500



0276



### Stainless steel trowel with rounded edges, MASTER LINE XL

Paca nierdzewna, Glättkelle, Edelstahl, glatt  
Ergonomic, balanced, shaped 3k soft handle  
on jacking foot made by polyamide with fiberglass.  
Stainless, acid resistant steel, thickness: 0,7mm.

For application of gypsum plaster, thanks  
to two rounded edges it leaves less visible marks.

no.	dimensions	pcs.	ean
0276	130x270mm	1/10	5 909202 027600



0277



### Stainless steel trowel with rounded edges, MASTER LINE XL

Paca nierdzewna z zębem, Glättkelle, Edelstahl, glatt  
Ergonomic, balanced, shaped 3k soft handle  
on jacking foot made by polyamide with fiberglass.  
Stainless, acid resistant steel, thickness: 0,7mm.

Float for spreading self-flowing, thick-layer and deformable  
adhesives on large-format tiles. Provides maximum coverage  
of the tile with glue.

no.	dimensions	pcs.	ean
0277	130x270mm, notch 15x20	1/10	5 909202 027700



0278  
0279



### Stainless steel trowel with skewed notch, MASTER LINE XL

Paca nierdzewna z zębem, Zahnkelle, Edelstahl-Zahnung  
Ergonomic, balanced, shaped 3k soft handle  
on jacking foot made by polyamide with fiberglass.  
Stainless, acid resistant steel, thickness: 0,7mm.

For distribution of adhesive mortars, using method of  
spring fixing of glaze tiles. Guarantees maximum  
tile covering with the adhesive.

no.	dimensions	pcs.	ean
0279	130x270mm, notch 8	1/10	5 909202 027900
0278	130x270mm, notch 10	1/10	5 909202 027800

### Stainless steel trowel, smooth, MASTER LINE

Paca nierdzewna gładka, Glättkelle, Edelstahl,  
Ergonomic, balanced, shaped, 3k soft handle  
on jacking foot made by polyamide with fiberglass.  
Stainless, acid resistant steel, thickness: 0,7mm.  
For application of gypsum plaster, mortars and adhesives (0260).  
Stainless steel trowel, notched (0261, 0262, 0263, 0264, 0265).  
For distribution of adhesive mortars.

no.	dimensions	pcs.	ean
0260	130x270mm	1/10	5 907796 0260 5
0261	130x270mm, notch 4x4	1/10	5 907796 0261 5
0262	130x270mm, notch 6x6	1/10	5 907796 0262 5
0263	130x270mm, notch 8x8	1/10	5 907796 0263 5
0264	130x270mm, notch 10x10	1/10	5 907796 0264 5
0265	130x270mm, notch 12x12	1/10	5 907796 0265 5



**Kubala®**  
MASTER LINE



0261  
0262  
0263  
0264  
0265

### Stainless steel trowel with rounded edges, MASTER LINE

Paca nierdzewna, Glättkelle, Edelstahl,  
Ergonomic, balanced, shaped 3k soft handle  
on jacking foot made by polyamide with fiberglass.  
Stainless, acid resistant steel, thickness: 0,7mm.  
For application of gypsum plaster, thanks  
to two rounded edges it leaves less visible marks.

no.	dimensions	pcs.	ean
0266	130x270mm	1/10	5 907796 0266 5



**Kubala®**  
MASTER LINE



### Stainless steel trowel with rounded edges, MASTER LINE

Paca nierdzewna, Glättkelle, Edelstahl,  
Ergonomic, balanced, shaped 3k soft handle  
on jacking foot made by polyamide with fiberglass.  
Stainless, acid resistant steel, thickness: 0,7mm.  
Float for spreading self-flowing, thick-layer and deformable  
adhesives on large-format tiles. Provides maximum coverage  
of the tile with glue.

no.	dimensions	pcs.	ean
0267	130x270mm, notch 15x20	1/10	5 907796 0267 5



**Kubala®**  
MASTER LINE

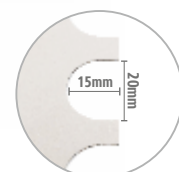

### Stainless steel trowel with skewed notch, MASTER LINE

Paca nierdzewna, Glättkelle, Edelstahl,  
Ergonomic, balanced, shaped 3k soft handle  
on jacking foot made by polyamide with fiberglass.  
Stainless, acid resistant steel, thickness: 0,7mm.  
For distribution of adhesive mortars, using method of  
spring fixing of glaze tiles. Guarantees maximum  
tile covering with the adhesive.

no.	dimensions	pcs.	ean
0268	130x270mm, notch 10	1/10	5 907796 0268 5



**Kubala®**  
MASTER LINE





### Stainless steel trowel, smooth

Paca nierdzewna, gładka, Glättkelle, Edelstahl, glatt  
Ergonomic, balanced, shaped handle made of beech wood  
on jacking foot made by polyamide with fiberglass.  
Stainless, acid resistant steel, thickness: 0,7mm.  
For application of gypsum plaster, mortars and adhesives.

no.	dimensions	pcs.	ean
0475	130x270mm	1/10	



### Stainless steel trowel, smooth

Paca nierdzewna gładka, Glättkelle, Edelstahl, glatt  
Ergonomic and balanced handle made of beech wood,  
on extended aluminium jacking foot, guarantees better stability  
of the working part. Stainless, acid resistant steel, thickness: 0,7mm.  
For application of gypsum plasters, mortars and adhesives.

no.	dimensions	pcs.	ean
0472	130x270mm	1/10	



### Stainless steel trowel, angular

Paca nierdzewna, kątowna, Kantenstreicher, Glättkelle, Edelstahl  
Ergonomic, balanced and shaped handle made of PS.  
Stainless, acid resistant steel, thickness: 0,7mm.  
For plaster finishing in corners.

no.	dimensions	pcs.	ean
0483	100x270x30mm	1/10	



### Stainless steel trowel, half-rounded

Paca nierdzewna, półokrągła, Glättkelle, Edelstahl, halbrund  
Ergonomic, balanced and shaped handle made of PS.  
Stainless, acid resistant steel, thickness: 0,7mm.  
For application of plasters, thanks to rounded working  
part it leaves less visible marks while working.

no.	dimensions	pcs.	ean
0420	105x325mm	1/10	





## STAINLESS STEEL TROWELS



### Stainless steel trowel conic

Paca nierdzewna, stożkowa, Venezianische Glättkelle  
Ergonomic, balanced 2k soft handle  
on jacking foot made by polyamide with fiberglass.  
Stainless, acid resistant steel, thickness: 0,3mm.  
For application and structuring of decorative plasters,  
including travertine.

no.	dimensions	pcs.	ean
0499	70x230mm	1/10	



### Stainless steel 'venice' trowel

Paca nierdzewna, "wenecka", Glättkelle, Edelstahl, "venezianisch"  
Ergonomic, balanced and shaped 2k soft handle  
on jacking foot made by polyamide with fiberglass.  
Stainless, acid resistant steel, thickness: 0,7mm, half-mirror polished,  
ground edges (secured and covered), rounded edges.  
For gypsum stucco works.

no.	dimensions	pcs.	ean
0458	80x200mm	1/10	
0459	75x95x240mm	1/10	



### Stainless steel 'venice' trowel

Paca nierdzewna, "wenecka", Glättkelle, Edelstahl, "venezianisch"  
Ergonomic, balanced, shaped handle made of beech  
wood on jacking foot made by polyamide with fiberglass.  
Stainless, acid resistant steel, thickness: 0,7mm, mirror polished,  
ground edges, (secured and covered), rounded edges.  
For gypsum stucco works.

no.	dimensions	pcs.	ean
0456	80x200mm	1/10	
0457	75x95x240mm	1/10	



### Stainless steel trowel, smooth

Paca nierdzewna, gładka, Glättkelle, Edelstahl, glatt  
Ergonomic, balanced, shaped 2k soft handle  
on extended jacking foot made by polyamide with fiberglass.  
Extended jacking foot guarantees better stability of the working part.  
Stainless, acid resistant steel, thickness: 0,7mm.  
For application of dust free gypsum plasters.

no.	dimensions	pcs.	ean
0489	130x350mm	1/6	
0490	130x405mm	1/10	

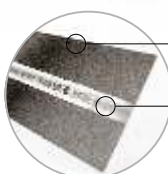

Float grinded from the bottom alongside the longer edges and through its center.

### Stainless steel trowel, LARGE FORMAT

Paca nierdzewna, WIELKI FORMAT,  
Glättkelle, Edelstahl, GROSSES FORMAT

Ergonomic, balanced, shaped 2k soft handle on extended jacking foot made by polyamide with fiberglass. Extended jacking foot guarantees better stability of the working part. Stainless, acid resistant steel, thickness: 0,7mm. Float for spreading self-flowing, thick-layer and deformable adhesives on large-format tiles.



no.	dimensions	pcs.	ean
0258	130x355mm, notch 12x16	1/10	

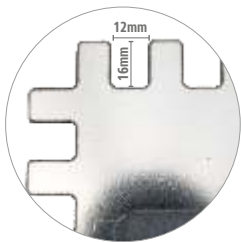

The height and shape of the tooth allow for a single layer of adhesive to be applied to the working surface, as well as a thin reinforcing layer on the tile (combined method used in tiling)



The special shape, rounded inner and outer corners ensure that the previously applied insulation coating is not damaged



\* SBW - an industry association established to improve the professional qualifications of contractors.

### Trowel for joining plasterboards,

Paca nierdzewna GK, Kantenstreicher, Glättkelle, Edelstahl  
Ergonomic, balanced, shaped, 3k soft handle on extended aluminium jacking foot, guarantees better stability of the working part. Stainless, acid resistant steel, thickness: 1 mm. For joining plasterboards.



no.	dimensions	pcs.	ean
0280	130x350mm	1/10	

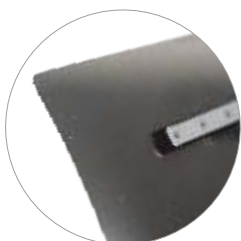

The specially contoured concave working part, with the appropriate cutout, completely eliminating any spillage beyond the defined surface

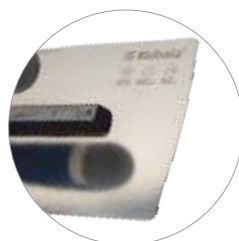

The convex part is used for embedding reinforcing tapes at the recommended depth



The use of this trowel eliminates errors commonly made during the treatment of gypsum board joints

## STAINLESS STEEL TROWELS



### Steel trowel, "sharp"

Paca nierdzewna, "ostra", Steinh Holzglätter, Metal "spitz"  
Ergonomic handle made of beech wood, natural.  
Steel thickness: 1,0mm.  
For floor surfaces.

no.	dimensions	pcs.	ean
0421	90x500mm	1/10	5 077926 00226 0
0422	90x600mm	1/10	5 077926 00226 0



### Stainless steel trowel, "sharp"

Paca nierdzewna, "ostra", Edelstahl, "spitz"  
Ergonomic, balanced, shaped handle made of beech wood, varnished. Stainless, acid resistant steel, thickness: 1,0mm.  
For floor surfaces.

no.	dimensions	pcs.	ean
0431	90x500mm	1/10	5 077926 00226 0



0409  
0410  
0411  
0412



### Stainless steel trowel

Paca nierdzewna, Aufziehglätte, Edelstahl  
Ergonomic, balanced, shaped handle made of beech wood, varnished. Stainless, acid resistant steel, thickness: 0,7mm.  
For application of gypsum plasters, mortars and adhesives (0407, 0408). For distribution of adhesive mortars and adhesives for net in thermal insulation works (0409, 0410, 0411, 0412).

no.	dimensions	pcs.	ean
0407	130x380mm, smooth	1/4	5 077926 00226 0
0408	130x480mm, smooth	1/4	5 077926 00226 0
0409	130x480mm, notch 6x6	1/4	5 077926 00226 0
0410	130x480mm, notch 8x8	1/4	5 077926 00226 0
0411	130x480mm, notch 10x10	1/4	5 077926 00226 0
0412	130x480mm, notch 12x12	1/4	5 077926 00226 0



### Stainless steel trowel, smooth

Paca nierdzewna, gładka, Aufziehglätte, Edelstahl, glatt  
Ergonomic, balanced, shaped handle made of beech wood, varnished.  
Stainless, acid resistant steel, thickness: 0,7mm.  
For application of gypsum plasters, mortars and adhesives.

no.	dimensions	pcs.	ean
0423	130x580mm	1/4	5 077926 00226 0
0413	130x680mm	1/4	5 077926 00226 0

### Stainless steel trowel, smooth with rounded edges, MASTER LINE

Paca nierdzewna, Aufziehglätte, Edelstahl, glatt

Ergonomic, shaped 3k soft handle.

Stainless, acid resistant steel, thickness: 0,7mm.

For application of gypsum plasters, thanks to two rounded edges it leaves less visible marks.



no.	dimensions	pcs.	ean
0256	130x480mm	1/4	



### Stainless steel trowel with half-round notches, MASTER LINE

Paca nierdzewna z zębem półokrągłym, Zahnekelle, Edelstahl-Zahnung

Ergonomic, balanced, shaped 3k soft handle.

Stainless, acid resistant steel, thickness: 0,7mm.

For distribution of self-levelling, thick-layered and formable adhesives on large format tiles.

Guarantees maximum tile covering with the adhesive.



no.	dimensions	pcs.	ean
0257	130x480mm	1/4	



### Stainless steel trowel MASTER LINE

Paca nierdzewna, Aufziehglätte, Edelstahl

Ergonomic, shaped 3k soft handle.

Stainless, acid resistant steel, thickness: 0,7mm.

For distribution of self-levelling, trick-layered and formable adhesives on large format tiles.

Guarantees maximum tile covering with adhesive (0250).

For distribution of adhesive mortars and adhesives for net in thermal insulation works (0253, 0254).



no.	dimensions	pcs.	ean
0250	130x480mm, smooth	1/4	
0253	130x480mm, notch 8x8	1/4	
0254	130x480mm, notch 10x10	1/4	

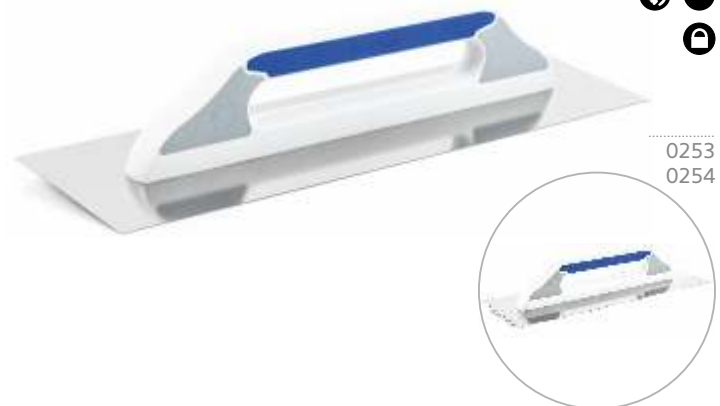

0253  
0254





## 5 REASONS IT IS WORTH USE OUR PRODUCT

### WORK FOR ONE PERSON



### EASY TO STRAIGHTEN THE CEILING

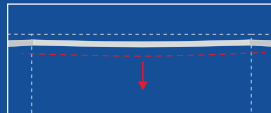

### SAVING TIME AND MATERIALS

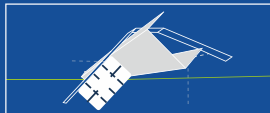

### FAST INSTALLATION OF WALLS



### INSTALLATION OF SECOND-LEVEL PROFILES

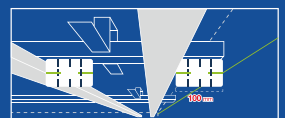
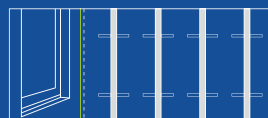
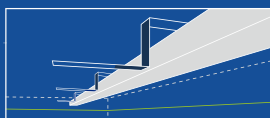
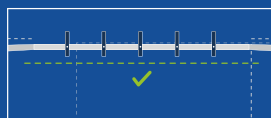
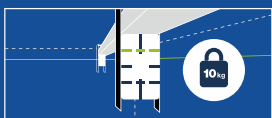
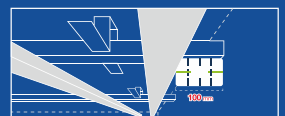
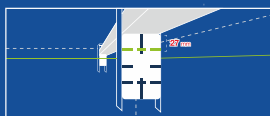
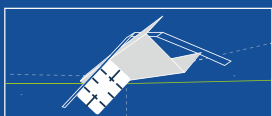
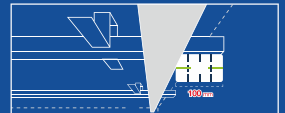

### HOW TO USE



## INNOVATION FOR DRYWALL INSTALATION



### Drywall track installation magnet SMART INSTALL

Magnes SMART INSTALL, Magnet SMART INSTALL  
Drywall track installation magnet (device). Strong magnet is an aid for quick assembly and levelling of drywall metal frame. Laser-engraved lines on the magnet will make the work easier and faster.

no.	dimensions	pcs.	ean
0675	100x60mm, 704g	1/6	



**STRONG  
MAGNET**

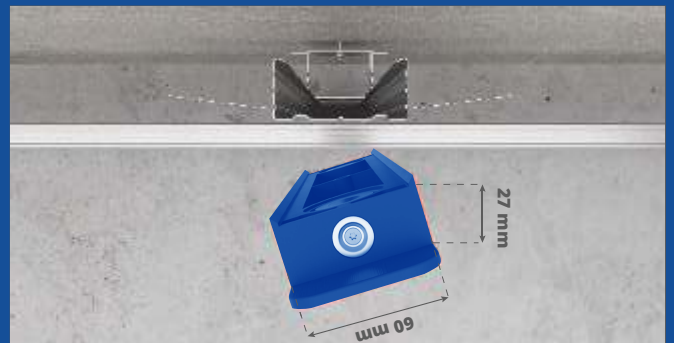
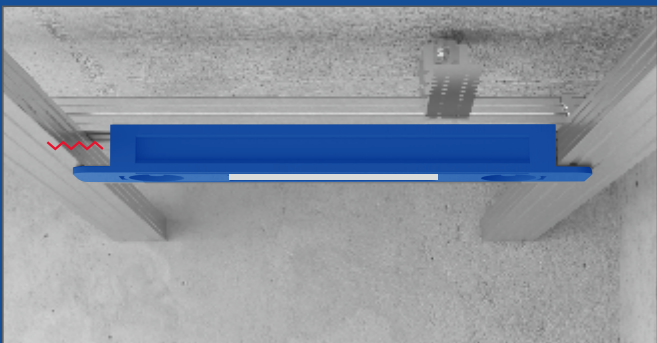
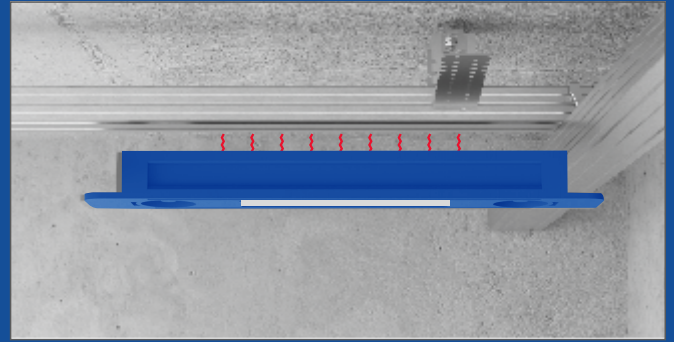
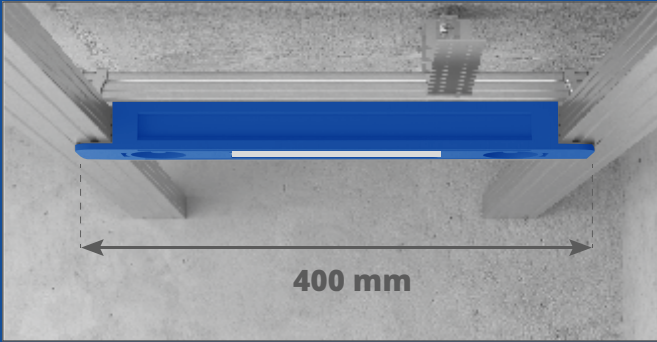

## HOW TO USE



Would you like to further improve the operation of **SMART DISTANCE**, **BUY SMART INSTALL**

### SMART DISTANCE

#### SMART DISTANCE, SMART DISTANCE

Made of ABS plastic with 4 neodymium magnets. Smart Distance, thanks to its special design and appropriate size, allows for independent installation of CD60 profiles in a cross system. The use of this tool reduces adjustment time by 50%. It replaces all tools typically used for profile installation.



no.	dimensions	pcs.	ean
0676	400mm	1/10	



**STRONG  
MAGNET**



## PLASTER TOOLS



**Kubala®**  
MASTER LINE

0651



0650



**Kubala®**  
MASTER LINE

0631



0630



### Tool case for plaster tools, MASTER SET

Walizka z narzędziami do gładzi MASTER SET,  
Werkzeug - Kofferset MASTER SET

The suitcase includes:

- 0623 Stainless steel putty knife with replaceable blade for finishing plaster 200 mm, MASTER LINE
- 0625 Stainless steel putty knife with replaceable blade for finishing plaster 400 mm, MASTER LINE
- 0627 Stainless steel putty knife with replaceable blade for finishing plaster 600 mm, MASTER LINE
- 0628 Stainless steel putty knife with replaceable blade for finishing plaster 800 mm, MASTER LINE
- 0629 Stainless steel putty knife with replaceable blade for finishing plaster 1000 mm, MASTER LINE
- 0620 Adapter for stainless steel putty knife, MASTER LINE
- 0615 Aluminum telescopic pole, MASTER LINE
- 0614 230 mm plaster roller, 2K soft handle
- 0528 Stainless steel spatula 150mm, 2K soft handle, SILVER LINE

no.	dimensions	psc.	ean
0650	1170x400x120mm empty case	1/1	
0651	1170x400x120mm MASTER SET	1/1	

### Tool case for plaster tools, MASTER SET MINI

Walizka z narzędziami do gładzi MASTER SET MINI,  
Werkzeug - Kofferset MASTER SET MINI

The suitcase includes:

- 0624 Stainless steel putty knife with replaceable blade for finishing plaster 300 mm, MASTER LINE
- 0627 Stainless steel putty knife with replaceable blade for finishing plaster 600 mm, MASTER LINE
- 0628 Stainless steel putty knife with replaceable blade for finishing plaster 800 mm, MASTER LINE
- 0620 Adapter for stainless steel putty knife, MASTER LINE
- 0616 Aluminum telescopic pole 135 cm, MASTER LINE



no.	dimensions	psc.	ean
0630	970x250x100mm empty case	1/1	
0631	970x250x100mm MASTER SET	1/1	

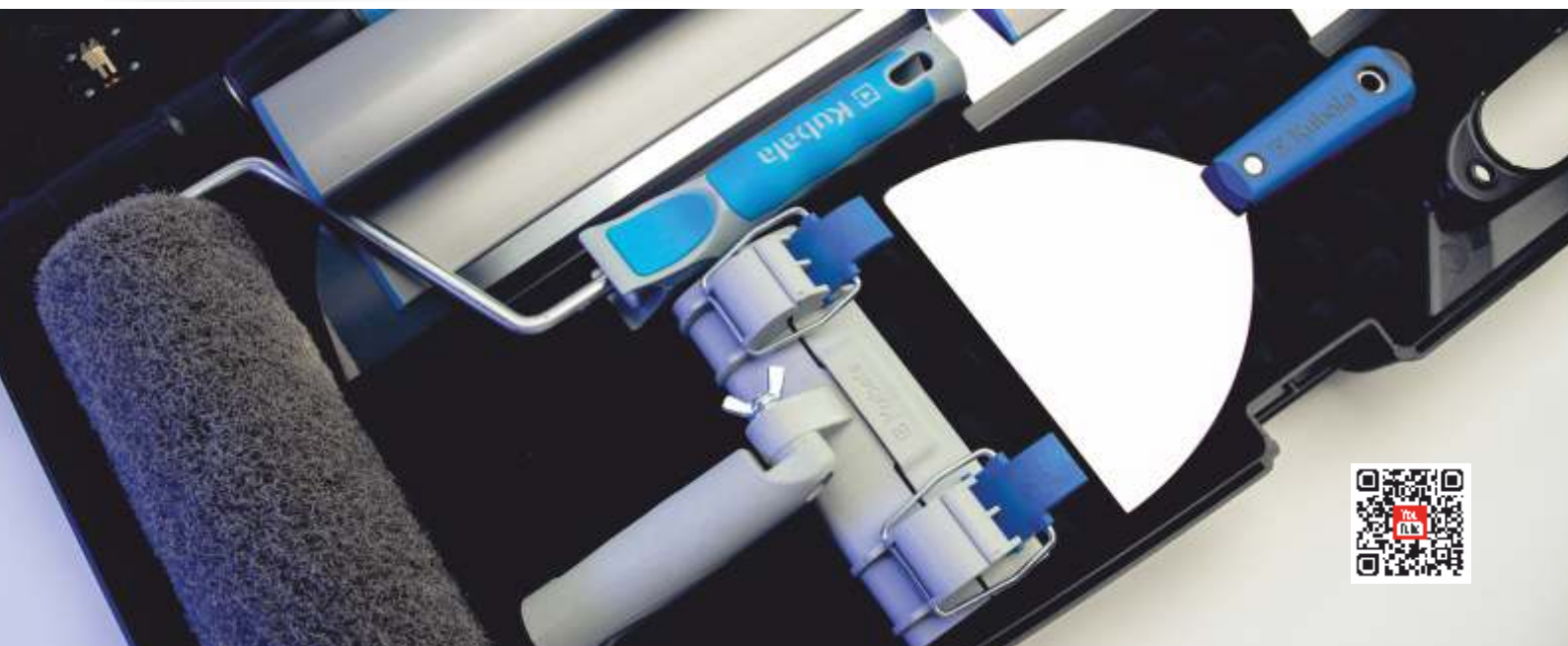



## Stainless steel putty knife with replaceable blade for finishing plaster, MASTER LINE

Szpachla nierdzewna z wymiennym ostrzem do gładzi MASTER LINE,  
Flächenspachtel mit wechselblatt MASTER LINE

The functional part of the spatula made from stainless steel.  
Ergonomic shape of the handle to work with one or both hands.  
Flexible blade with rounded edges do not scratch the ground.  
Thickness 0,3 mm.

no.	dimensions	pcs.	ean
0623	200mm	1/4	5 907798 06230
0624	300mm	1/4	5 907798 06240
0625	400mm	1/4	5 907798 06250
0627	600mm	1/4	5 907798 06270
0628	800mm	1/4	5 907798 06280
0629	1000mm	1/4	5 907798 06290
0633	replacement blade 200mm	1/10	5 907798 06330
0634	replacement blade 300mm	1/10	5 907798 06340
0635	replacement blade 400mm	1/10	5 907798 06350
0637	replacement blade 600mm	1/10	5 907798 06370
0638	replacement blade 800mm	1/10	5 907798 06380
0639	replacement blade 1000mm	1/10	5 907798 06390



instructions for use



## Adapter for stainless steel putty knife, MASTER LINE

Adapter do szpachli z wymiennym ostrzem  
Adapter für Flächenspachtel mit Wechselblattsystem  
Adapter dedication to stainless steel putty knife Kubala  
(0623,0624,0625,0627,0628,0629).

Made by polyamide with fiberglass .

no.	dimensions	pcs.	ean
0620		1/10	5 907798 06200



quick holder regulation  
quick fitting to finishing knife



## Telescopic stick aluminium

Kij teleskopowy aluminiowy, Teleskopstange aluminium  
Made of aluminum.

The stick is equipped with a special tip that allows trouble-free assembly to stainless steel putty knife Kubala.

no.	dimensions	pcs.	ean
0615	2m	1/6	5 907798 06150
0616	135cm	1/6	5 907798 06160

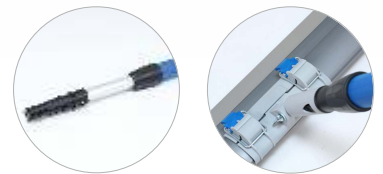

## Roller for applying finish coat

Wałek do gładzi, Beschichtungsrolle  
Ergonomic, balanced and shaped 2k soft handle.  
Made by polyamide. It collects putty mass perfectly and then spreads it thoroughly on the wall or ceiling.  
For all types of ready-made masses.

no.	dimensions	pcs.	ean
0614	230mm	1/10	5 907798 06140
0613	roller refill 0614 230mm	1/10	5 907798 06130
0671	80mm	1/10	5 907798 06710
0670	roller refill 0671 80mm	1/10	5 907798 06700

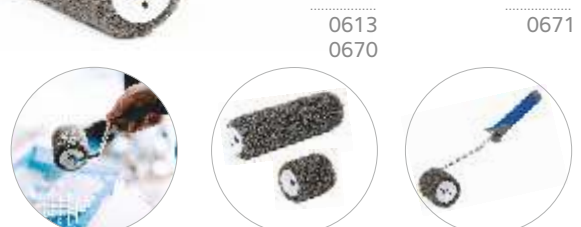

0613  
0670

0671



## PLASTER TOOLS / STAINLESS STEEL SPATULAS



### Stainless steel spatula

Szpachla nierdzewna do gładzi, Gipsspachtel, Edelstahl  
Ergonomic, shaped 2K soft handle.

Stainless, acid resistant steel, thickness: 0,4mm.

The working part installed in an aluminium hollow section, anodised to gain more strength and guarantee a perfectly even working edge.

Restricted product

no.	dimensions	pcs.	ean
0551	350mm	1/5	5 07798 05510
0552	500mm	1/5	5 07798 05520
0553	600mm	1/5	5 07798 05530



### Stainless steel spatula

Szpachla nierdzewna, Flächenspachtel, Edelstahl  
Ergonomic, shaped handle made of plywood.

Stainless, acid resistant steel, thickness: 0,3mm.

The working part installed in an aluminium hollow section, anodised to gain more strength and guarantee a perfectly even working edge. For gypsum plasters.

no.	dimensions	pcs.	ean
0563	350mm	1/10	5 07798 05630
0564	500mm	1/10	5 07798 05640
0565	600mm	1/8	5 07798 05650



### Stainless stripping knife 0,5mm, MASTER LINE

Szpachla nierdzewna fasadowa 0,5mm, MASTER LINE,  
Fassadenspachtel edelstahl 0,5mm, MASTER LINE

Stainless, acid resistant steel, thickness: 0,5mm

Ergonomic shape of the handle for working with one or both hands. Does not scratch the ground thanks to the rounded sides of the flexible blade.

no.	dimensions	pcs.	ean
0644	300mm	1/4	5 07798 06440
0647	600mm	1/4	5 07798 06470



### Stainless steel spatula, MASTER LINE

Szpachla nierdzewna, fasadowa, Fassadenspachtel, Edelstahl  
Ergonomic, shaped 3K soft handle..

Stainless, acid resistant steel, thickness: 0,5mm.

The working part installed in an aluminium hollow section, anodised to gain more strength and guarantee a perfectly even working edge. For construction and finishing works.

no.	dimensions	pcs.	ean
0533	350mm	1/5	5 07798 05330
0534	500mm	1/5	5 07798 05340
0535	600mm	1/5	5 07798 05350

### Polyamide handle for spatula

Uchwyt do szpachli fasadowe, Polyamidgriff für Spatel  
 Handle dedication to spatula  
 (0551, 0552, 0553, 0533, 0534, 0535).  
 Made by polyamide with fiberglass.



no.	dimensions	pcs.	ean
0549		1/10	

### Stainless steel spatula SILVER LINE

Szpachla nierdzewna SILVER LINE, Gipsspachtel, Edelstahl SILVER LINE  
 Ergonomic 2k soft handle ensures comfort during work.  
 Working part made of acid-resistant stainless steel, ground and polished.  
 "Conical" grinding of the working part results in high flexibility of the tool  
 near the edge of the spatula blade. Tool allows spreading the mass  
 with a very thin layer. Tool is ideal for finishing works.



no.	dimensions	pcs.	ean
0522	"25"	1/10	
0523	"35"	1/10	
0524	"60"	1/10	
0525	"75"	1/10	
0526	"100"	1/10	
0527	"125"	1/10	
0528	"150"	1/10	
0529	"200"	1/10	
0530	"250"	1/10	



### Stainless steel spatula

Szpachla nierdzewna, Gipsspachtel, Edelstahl  
 Ergonomic handle made of PP.  
 Stainless, acid resistant steel, thickness: 0,7mm.  
 For construction and finishing works.



no.	dimensions	pcs.	ean
0501	40mm	1/20	
0502	60mm	1/20	
0503	80mm	1/20	
0500	100mm	1/20	



### Stainless steel spatula

Szpachla nierdzewna, Gipsspachtel, Edelstahl  
 Ergonomic 2k soft handle.  
 Stainless, acid resistant steel, thickness: 0,7mm.  
 For construction and finishing works.



no.	dimensions	pcs.	ean
0585	40mm	1/20	
0586	60mm	1/20	
0587	80mm	1/20	
0588	100mm	1/20	



## STAINLESS STEEL SPATULAS



### Stainless steel spatula, multifunctional

Szpachla nierdzewna, wielofunkcyjna, Gipsspachtel, Edelstahl  
Ergonomic handle made of PP.  
Stainless, acid resistant steel, thickness: 1,0mm.  
For painting and finishing works.

no.	dimensions	pcs.	ean
0584	60mm	1/20	



**Kubala®**  
MASTER LINE



tip is made of raw aluminium allowing you to mark the wall

paint can opener

rollers cleaning cutout

nails removing hole

blade for peeling off old paint

### Stainless steel spatula, MASTER LINE

Szpachla nierdzewna uniwersalna, Gipsspachtel, Edelstahl  
Acid-resistant stainless steel, thickness 2.0 mm.  
3k soft handle. Tip is made of raw aluminium allowing you to mark the wall. Tool for painting and finishing works for: cleaning rollers, removing nails, opening paint cans blade for peeling off old paint.

no.	dimensions	pcs.	ean
0661	75mm	1/10	



### Stainless steel spatula

Szpachla nierdzewna, Flächenspachtel, Edelstahl  
Ergonomic, shaped 2k soft handle.  
Stainless, acid resistant steel, thickness: 0,5mm.  
The working part installed in an aluminium hollow section, anodised to gain more strength and guarantee a perfectly even working edge.  
For construction and finishing works.

no.	dimensions	pcs.	ean
0546	150mm	1/10	
0547	250mm	1/10	
0548	350mm	1/10	



### Universal spatula

Szpachla uniwersalna, Universalspachtel zweiseitig  
Handle made of PP.  
Steel thickness: 1,0mm, two types of endings.  
For joint pointing and painting works.

no.	dimensions	pcs.	ean
0578	16mm	1/20	
0579	24mm	1/20	

### Stainless steel spatula

Szpachla nierdzewna, Gipsspachtel, Edelstahl  
Ergonomic, shaped 2k soft handle.  
Stainless, acid resistant steel, thickness: 0,5mm.  
For construction and finishing works.

no.	dimensions	pcs.	ean
0571	120mm	1/20	
0572	140mm	1/20	
0573	160mm	1/20	
0574	180mm	1/20	



### Stainless steel spatula with bit

Szpachla nierdzewna z wkrętakiem, Gipsspachtel, Edelstahl  
Ergonomic handle made of PP.  
Stainless, acid resistant steel, thickness: 0,5mm.  
For construction and finishing works with bit PH2.

no.	dimensions	pcs.	ean
0545	150mm	1/20	



### Stainless steel spatula with a bit, MASTER LINE

Szpachla nierdzewna z bitem, Gipsspachtel, Edelstahl  
Working part made of acid-resistant stainless steel, conical grinded and polished the high elasticity of the edge of the spatula enables the spreading of a very thin layer of putty. 3k soft handle.  
Tip is made of raw aluminium allowing you to mark the wall. The bit is attached to the tip thanks to magnet glued in the hole.  
Tool for finishing works with the use of all types of putty.

no.	dimensions	pcs.	ean
0667	150mm	1/10	



Tip is made of raw aluminium allowing you to mark the wall



The bit be attached to the tip thanks to magnet glued in the hole



Instructions for use



## SPATULAS / PLASTIC SPATULA

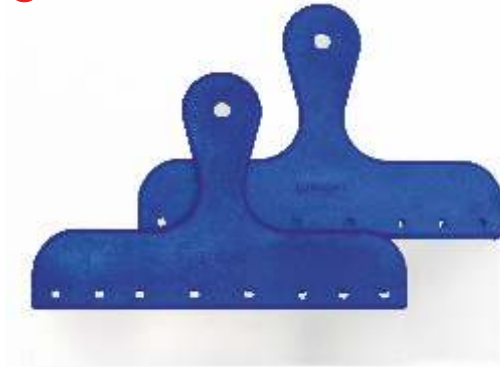

### Stainless steel spatula

Szpachla nierdzewna, Gipsspachtel, Edelstahl  
Handle made of PS.  
Stainless, acid resistant steel, thickness: 0,5mm.  
For construction and finishing works.

no.	dimensions	pcs.	ean
0510	250x85mm	1/20	5 077921 051017
0511	250x38mm	1/20	5 077921 051117



### Stainless steel spatula

Szpachla nierdzewna, Gipsspachtel, Edelstahl  
Ergonomic, shaped handle made of PS.  
Stainless, acid resistant steel, thickness: 0,5mm.  
For construction and finishing works.

no.	dimensions	pcs.	ean
0512	350x85mm	1/20	5 077921 051217
0513	335x35mm	1/20	5 077921 051317



### Stainless steel spatula

Szpachla nierdzewna, Gipsspachtel, Edelstahl  
Ergonomic, shaped handle made of beech wood.  
The handle consists of two parts, which protects the tool against deformations of the working part.  
Stainless, acid resistant steel, thickness: 0,5mm.  
For construction and finishing works.

no.	dimensions	pcs.	ean
0590	100mm	1/20	5 077921 059017
0591	120mm	1/20	5 077921 059117
0592	140mm	1/20	5 077921 059217
0593	160mm	1/20	5 077921 059317
0594	180mm	1/20	5 077921 059417
0595	200mm	1/20	5 077921 059517



### Stainless steel spatula

Szpachla nierdzewna, Gipsspachtel, Edelstahl  
Ergonomic handle made of PP.  
Stainless, acid resistant steel, thickness: 0,5mm.  
For painting and finishing work.

no.	dimensions	pcs.	ean
0508	130x85mm	1/20	5 077921 050817
0509	120x35mm	1/20	5 077921 050917

### Stainless steel spatula "Japan"

Szpachla nierdzewna "japońska", Japanspachtelsatz  
Handle made of PP.  
Stainless, acid resistant steel, thickness: 0,3mm.  
The set contains 4 sizes of stripping knives.  
For skimming of delicate surfaces.



no.	dimensions	pcs.	ean
1625	50,80,100,120mm	1/25	



### Stainless steel spatula for spreading glue

Rakla do rozprowadzania kleju, Rakel zur Klebstoffverteilung  
Ergonomic, shaped handle made of plywood.  
Stainless steel.  
Blade made of tempered steel, 4 mm tooth width.  
For spreading adhesive under the liner.



no.	dimensions	pcs.	ean
0570	560mm, notch 4x4	1/5	



### Steel spatula

Szpachla metalowa, Kleberspachtel, Stahl  
Handle made of PP.  
Steel thickness: 0,45mm.  
For distribution of mortars and glue on small surfaces.



no.	dimensions	pcs.	ean
0514	180mm, smooth	1/20	
0515	180mm, notch 4x4	1/20	
0516	180mm, notch 6x6	1/20	
0517	180mm, notch Δ 3	1/20	
0518	180mm, notch Δ 6	1/20	



### Stainless Steel Bucket Scoop

Szpachla nierdzewna WYBIERAK do wiadra,  
Spachtel zum Reinigen von Eimern  
Ergonomic and profiled 2K soft handle.  
Stainless, acid-resistant steel thickness: 0.5 mm, with increased flexibility and elasticity. Thanks to the right selection, the angles and elasticity of the sheet metal, the putty perfectly adjusts into the bucket, causing the weight to be picked up accurately from the bucket.



no.	dimensions	pcs.	ean
0540	160mm	1/10	



## PLASTIC SPATULAS



### Plastic spatula

Szpachla z tworzywa, Spachtel, Kunststoff

Plastic PS.

Ergonomic, shaped handle.

For distribution of mortars and adhesives on small surfaces.

no.	dimensions	pcs.	ean
0701	235mm, smooth	1/20	
0702	235mm, notch 4x6	1/20	
0703	235mm, notch 6x6	1/20	



### Universal plastic spatula

Szpachla z tworzywa, Kunststoffspachtel gezahnt

Plastic PS.

For distribution of mortars and adhesives on small surfaces.

no.	dimensions	pcs.	ean
0706	175x130mm	1/20	
0708	90x135mm	1/20	



### Plastic spatula

Szpachla z tworzywa, Spachtel, Kunststoff

Plastic ABS.

For skimming of delicate surfaces.

no.	dimensions	pcs.	ean
0704	80mm	1/10	
0705	100mm	1/10	
0707	150mm	1/10	



### Plastic spatula "Japan"

Szpachla z tworzywa "japońska", Japanspachtelsatz

Plastic PP.

The set contains four sizes of stripping knife.

For skimming of delicate surfaces.

no.	dimensions	pcs.	ean
1624	50,80,100,120mm	1/25	

### Universal tool "K"

Przyrząd uniwersalny "K", Silikon Fugenspachtel "K"

Black: plastic PE.

For filling and shaping of joints.

Blue: rubber.

For filling and shaping of silicone joints.

no.	dimensions	pcs.	ean
1614	black	1/20	
1628	blue	1/20	



### Rubber spatula

Szpachla gumowa, Fugengummi/Fliesenwischer

Plastic handle PP.

Rubber thickness: 7mm.

For water extraction from large surfaces.

no.	dimensions	pcs.	ean
0607	440mm	1/10	



### Rubber spatula

Szpachla gumowa, Fugengummi

Shaped handle made of beech wood.

White rubber thickness: 8mm.

For the application of cement joints.

no.	dimensions	pcs.	ean
0601	135mm	1/10	
0602	200mm	1/10	
0603	250mm	1/10	





## MASONRY TROWELS



### Triangular trowel

Kielnia trójkątna, Dreieckmaurerkelle, Stahl

Ergonomic 2k soft handle.

Double sided grinded steel, thickness 1,2mm, welded. Perfectly balanced.

For bricklaying and plastering works.

no.	dimensions	pcs.	ean
0801	200x190mm	1/10	
0802	220x215mm	1/10	
0813	160x140mm	1/10	



### Triangular trowel

Kielnia trójkątna, Dreieckmaurerkelle, Stahl

Ergonomic 2k soft handle.

Double sided grinded steel, thickness: 1,2mm, welded.

Perfectly balanced. Sharp corners.

For bricklaying and plastering works.

no.	dimensions	pcs.	ean
0815	200x190mm	1/10	



### Trapezoid trowel

Kielnia trapezowa, Trapezmaurerkelle, Stahl

Ergonomic 2k soft handle.

Double sided grinded steel, thickness: 1,2mm, welded. Perfectly balanced.

For bricklaying and plastering works.

no.	dimensions	pcs.	ean
0803	120x180x80mm	1/10	



### Trapezoid trowel

Kielnia trapezowa, Trapezmaurerkelle, Stahl

Ergonomic 2k soft handle.

Double sided grinded steel, thickness: 1,2mm, welded. Straight jacking feet.

For bricklaying and plastering works.

no.	dimensions	pcs.	ean
0811	120x180x80mm	1/10	

### Stainless steel triangular trowel



Kielnia nierdzewna trójkątna, Dreieckmaurerkelle, Edelstahl  
Ergonomic handle made of beech wood.  
Stainless, acid resistant, double sided grinded steel,  
thickness: 1,2mm, welded. Perfectly balanced.  
For bricklaying and plastering works.

no.	dimensions	pcs.	ean
0807	200x190mm	1/10	



### Triangular trowel

Kielnia trójkątna, Dreieckmaurerkelle, Stahl  
Ergonomic handle made of beech wood.  
Double sided grinded steel, thickness: 1,2mm,  
welded. Perfectly balanced.  
For bricklaying and plastering works.

no.	dimensions	pcs.	ean
0804	200x190mm	1/10	
0805	220x215mm	1/10	



### Trapezoid trowel





Kielnia trapezowa, Trapezmaurerkelle, Stahl  
Ergonomic handle made of beech wood.  
Double sided grinded steel, thickness: 1,2mm,  
welded.  
Perfectly balanced.  
For bricklaying and plastering works.

no.	dimensions	pcs.	ean
0806	120x180x80mm	1/10	



### Stainless steel trowel, trapezoid

Kielnia nierdzewna trapezowa, Stuckateurkelle, Edelstahl  
Ergonomic handle made of beech wood, varnished.  
Stainless, acid resistant steel, thickness: 1,0mm, welding.  
For stucco and finishing works.

no.	dimensions	pcs.	ean
0808	115x160x90mm	1/20	
0809	120x180x80mm	1/20	
0810	120x180x90mm	1/20	
0901	80x145x55mm	1/20	



## MASONRY TROWELS / STUCCO TROWELS



### Stainless steel trowel, trapezoid

Kielnia nierdzewna trapezowa, Stuckateurkelle, Edelstahl  
Ergonomic 2k soft handle.

Stainless, acid resistant steel thickness: 1,0mm, welding.  
For stucco and finishing work.

no.	dimensions	pcs.	ean
0812	115x160x90mm	1/20	



### Round steel trowel

Kielnia stalowa półokrągła, Maurerkelle, Stahl  
Ergonomic handle made of beech wood with the FSC certificate.  
Steel with increased hardness and flexibility.

Conical grinding of the working part results in high tool flexibility.  
Working surface secured with transparent lacquer.

no.	dimensions	pcs.	ean
0820	180mm	1/10	
0821	200mm	1/10	
0822	220mm	1/10	



### Stainless stucco trowel

Kielnia nierdzewna kąt zewnętrzny, Außen Eckstuckateurkelle, Edelstahl  
Ergonomic handle made of beech wood with the FSC certificate.

The working part is made of one piece of 0.5mm thick stainless, acid-resistant steel. Thanks to a properly selected angle, during use we get an angle of 90°.

For finishing works, including plastering of outside corners.

no.	dimensions	pcs.	ean
0923	97x140mm	1/10	



### Stainless stucco trowel

Kielnia nierdzewna kąt wewnętrzny, Innen Eckstuckateurkelle, Edelstahl  
Ergonomic handle made of beech wood with the FSC certificate.

The working part is made of one piece of 0.5mm thick stainless, acid-resistant steel. Thanks to a properly selected angle, during use we get an angle of 90°.

For finishing works, including plastering of inside corners.

no.	dimensions	pcs.	ean
0924	97x140mm	1/10	





### Stainless steel stucco trowel, angular

Kielnia nierdzewna kątowna, Inneneckstuckateurkelle, Edelstahl  
 Ergonomic handle made of beech wood, varnished.  
 Stainless, acid resistant steel thickness: 1,0mm.  
 For finishing works,  
 including plastering of inside corners.

no.	dimensions	pcs.	ean
0909	60x85mm	1/20	5 907792 090924
0910	75x110mm	1/20	5 907792 091024
0914	97x120mm	1/20	5 907792 091424



### Stainless steel stucco trowel, angular

Kielnia nierdzewna kątowna, Außenekstuckateurkelle, Edelstahl  
 Ergonomic handle made of beech wood, varnished.  
 Stainless, acid resistant steel thickness: 1,0mm.  
 For finishing works,  
 including plastering of outside corners.

no.	dimensions	pcs.	ean
0908	60x85mm	1/20	5 907792 090824
0913	97x120mm	1/10	5 907792 091324



### Stainless steel stucco trowel

Kielnia nierdzewna sztuigatorska, Stuckateurkelle, Edelstahl  
 Ergonomic handle made of beech wood, varnished.  
 Stainless, acid resistant steel thickness: 0,8mm; 1,0mm (0916),  
 welding.  
 For stucco and finishing works.

no.	dimensions	pcs.	ean
0912	50mm	1/20	5 907792 091224
0902	60mm	1/20	5 907792 090224
0903	80mm	1/20	5 907792 090324
0904	100mm	1/20	5 907792 090424
0916	120mm	1/20	5 907792 091624





## STUCCO TROWELS



### Stainless steel stucco trowel "sharp"

Kielnia sztukatorska "ostra", Stuckateurkelle, Edelstahl  
Ergonomic handle made of beech wood with the FSC certificate, varnished. Stainless, acid resistant steel thickness: 0,8mm, welding. For stucco and finishing works.

no.	dimensions	pcs.	ean
0905	80x140mm	1/20	



### Stainless steel stucco trowel

Kielnia nierdzewna sztukatorska, Stuckateurkelle, Edelstahl  
Ergonomic handle made of beech wood with the FSC certificate, varnished. Stainless, acid resistant steel thickness: 1,0mm, welding. For finishing works.

no.	dimensions	pcs.	ean
0911	80x83mm	1/20	



### Stainless steel stucco trowel

Kielnia nierdzewna sztukatorska, Stuckateurkelle, Edelstahl  
Ergonomic handle made of beech wood with the FSC certificate, varnished. Stainless, acid resistant steel thickness: 1,0mm, welding. For stucco works and finishing works.

no.	dimensions	pcs.	ean
0906	55x160x20mm	1/20	



### Stainless steel stucco trowel

Kielnia nierdzewna sztukatorska, Stuckateurkelle, Edelstahl  
Ergonomic handle made of beech wood with the FSC certificate, varnished. Stainless, acid resistant steel thickness: 1,0mm, welding. For stucco works and finishing works.

no.	dimensions	pcs.	ean
0907	20x160x55mm	1/20	



### Stainless steel stucco trowel, MASTER LINE

Kielnia nierdzewna sztukatorska, Stuckateurkelle, Edelmetall  
Ergonomic 3K soft handle.

Stainless, acid resistant steel thickness: 0,8mm, welding.  
For stucco works and finishing works.

no.	dimensions	pcs.	ean
0932	60mm	1/20	5 020 793 0932 2
0933	80mm	1/20	5 020 793 0933 2
0934	100mm	1/20	5 020 793 0934 2
0947	120mm	1/20	5 020 793 0947 2



### Stainless steel stucco trowel, MASTER LINE

Kielnia nierdzewna sztukatorska, Stuckateurkelle, Edelmetall  
Ergonomic 3K soft handle.

Stainless, acid resistant steel thickness: 1,0mm, welding.  
For stucco works and finishing works.

no.	dimensions	pcs.	ean
0930	80x145x55mm	1/20	5 020 793 0930 2



## STUCCO TROWELS



### Joint pointing trowel

Kielnia do spoin, Fugenkelle

Ergonomic handle made of beech wood with the FSC certificate.

Hardened steel thickness: 2,0mm.

For joint pointing, including clinker.

no.	dimensions	pcs.	ean
1121	8mm	1/10	5 907798 11212 2
1122	10mm	1/10	5 907798 11222 2
1123	12mm	1/10	5 907798 11232 2



### Stainless steel joint pointing trowel

Kielnia do spoin nierdzewna, Fugenkelle, Edelstahl

Ergonomic 2K soft handle.

Stainless, acid resistant steel thickness: 1,2mm.

For joint pointing, including clinker.

no.	dimensions	pcs.	ean
1111	8mm	1/10	5 907798 11112 2
1112	10mm	1/10	5 907798 11122 2
1113	12mm	1/10	5 907798 11132 2



### Stainless steel trowel, jointed

Kielnia nierdzewna, spawana, Trapezstuckateurkelle, Edelstahl

Ergonomic 3K soft handle.

Stainless, acid resistant, double sided grinded steel, thickness: 1,2mm, welded.

For stonecutting and bricklaying works.

no.	dimensions	pcs.	ean
0951	80x145x55mm	1/20	5 907798 09512 2



### Stainless steel trowel, jointed

Kielnia nierdzewna, spawana, Stuckateurkelle, Edelstahl

Ergonomic 3K soft handle.

Stainless, acid resistant, double sided grinded steel, thickness: 1,2mm, welded.

For stonecutting and bricklaying works.

no.	dimensions	pcs.	ean
0952	60mm	1/20	5 907798 09522 2
0953	80mm	1/20	5 907798 09532 2
0954	100mm	1/20	5 907798 09542 2

### Stucco trowel

Kielnia sztukatorska, Stuckateurkelle, Stahl, "Berner Putzkelle"  
Ergonomic handle made of beech wood with the FSC certificate, varnished. Steel thickness: 1,2mm.  
For construction and finishing works.

no.	dimensions	pcs.	ean
1001	80x145x55mm	1/20	5 077986 1002 2



### Stucco trowel

Kielnia sztukatorska, Stuckateurkelle, Stahl, "Schwäbchen"  
Ergonomic handle made of beech wood with the FSC certificate, varnished. Steel thickness: 1,2mm.  
For construction and finishing works.

no.	dimensions	pcs.	ean
1002	80mm	1/20	5 077986 1002 2
1003	100mm	1/20	5 077986 1003 0



### Steel trowel

Kielnia spawana, Stuckateurkelle, Stahl, geschweißt "Berner Putzkelle"  
Ergonomic handle made of beech wood, varnished.  
Double sided grided steel, thickness: 1,2mm, welded.  
For stonecutting and bricklaying works.

no.	dimensions	pcs.	ean
1011	80x145x55mm	1/20	5 077986 1011 2



### Steel trowel

Kielnia spawana, Stuckateurkelle, Stahl, geschweißt  
Ergonomic handle made of beech wood, varnished.  
Double sided grided steel, thickness: 1,2mm, welded.  
For stonecutting and bricklaying works.

no.	dimensions	pcs.	ean
1012	60mm	1/20	5 077986 1012 2
1013	80mm	1/20	5 077986 1013 2
1014	100mm	1/20	5 077986 1014 2





## SCRAPERS



### Steel plaster scraper

Zdzierak do tynków stalowy, Ausgleichbrett für Putznivellierung, Stahl  
Handle covered with PE.  
Steel, welded.  
For plaster smoothing.

no.	dimensions	pcs.	ean
1401	145x285mm	1/10	

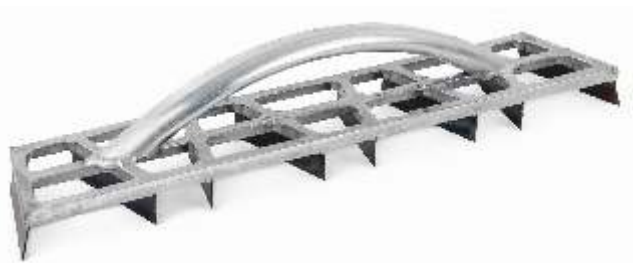

### Plaster scraper

Zdzierak do tynków, Ausgleichbrett für Putznivellierung  
Made of aluminium.  
8 steel blades.  
For plaster smoothing.

no.	dimensions	pcs.	ean
1402	465x90mm	1/10	



### Plaster scraper

Zdzierak do tynków, Putzkratzer  
Made of polyamide with fiberglass .  
8 steel blades.  
For plaster smoothing.

no.	dimensions	pcs.	ean
1424	465x90mm	1/10	



**Kubala®**  
MASTER LINE



### Plaster scraper, MASTER LINE

Zdzierak do tynków, Edelputzkratzer aus Zinkblech  
Ergonomic, shaped 3K soft handle.  
Working part made of galvanised sheets with "burrs".  
For removing of outside plaster layer.

no.	dimensions	pcs.	ean
1418	130x250mm	1/10	

### Wool coarse scraper, MASTER LINE

Zdzierak do wełny, Wolleschaber

Ergonomic, shaped 3K soft handle.

Working part made of galvanised sheets.

For stripping and levelling facade wool.

**Kubala®**  
MASTER LINE



no.	dimensions	pcs.	ean
1421	145x285mm	1/10	



### Plastic plaster scraper

Zdzierak do tynków, Ausgleichbrett für Putznivellierung

Plastic PS.

Ergonomic, shaped handle.

6 steel blades.

For plaster smoothing.



no.	dimensions	pcs.	ean
1403	270x90mm	1/10	



### Floor scraper

Zdzierak do posadzek, Fußbodenausgleichbrett, Metall

Metal, thickness: 1,4mm.

For tearing floors (1416).

Iron casting handle, working part thickness: 1,0mm.

For tile removing (1417).



no.	dimensions	pcs.	ean
1416	300mm	1/5	
1417	100mm	1/10	



1417



### Beater

Zbijak, Klopfer

Working part made of steel with thickness: 4mm,  
milled, sharp blade. Wooden grip 1050mm.

Total length: 1140mm.

For ice crushing.



no.	dimensions	pcs.	ean
1425	180x140mm	1/5	



## SCRAPERS / TOOLS FOR CELLULAR CONCRETE



### Joint cleaner

Skrobak do fug, Fugenkratzer

Plastic PP.

Cemented carbide blade, removable and changeable.  
For cement joint removal.

no.	dimensions	pcs.	ean
1404	30mm	1/25	5 909 792 000 1404
1405	50mm	1/25	5 909 792 000 1405
1410	30mm - blade	1/20	5 909 792 000 1410
1411	50mm - blade	1/20	5 909 792 000 1411



### Paint coat scrubber „scraper”

Zdzierak do farby "cyklina", Farbkratzer

Plastic PP.

Steel blade, removable and changeable.  
For paint removal and renovation of wooden surfaces.

no.	dimensions	pcs.	ean
1406	40mm	1/20	5 909 792 000 1406
1407	60mm	1/20	5 909 792 000 1407
1412	40mm - blade	1/20	5 909 792 000 1412
1413	60mm - blade	1/20	5 909 792 000 1413



### Wallpaper scrubber

Skrobak do tapet, Tapetenkratzer

Plastic handle PS.

Stainless steel working part, thickness: 0,3mm.  
For plaster and paint removal.

no.	dimensions	pcs.	ean
1419	88mm	1/30	5 909 792 000 1419



### Splitter handsaw

Piła płatnica, Porenbetonsäge

Beech wood handle with the FSC certificate.

Steel.

For block cutting in cellular concrete.

no.	dimensions	pcs.	ean
1740	17-teeth	1/5	5 077980 17402
1741	33-teeth	1/5	5 077980 17417



### Cellular concrete block scrubber

Zdzierak do bloczków, Porenbetonhobel

Made of wood.

10 steel edges, notched.

For cellular concrete block smoothing.

no.	dimensions	pcs.	ean
1730	450x100mm	1/8	5 077980 17300



### Cellular concrete block cutter

Przyrząd do cięcia, kątowny, Winkelscheidegerät

Metal.

Assisting tool in cutting of blocks from cellular concrete.

no.	dimensions	pcs.	ean
1709	270x270x270mm	1/10	5 077980 17090



### Drill with flange

Wiertło z kołnierzem, Spiralbohrer

Metal, galvanized.

For drilling in cellular concrete blocks.

no.	dimensions	pcs.	ean
1720	∅ 50mm	1/20	5 077980 17200
1721	∅ 60mm	1/20	5 077980 17210
1722	∅ 80mm	1/20	5 077980 17220
1723	∅ 120mm	1/20	5 077980 17230



## TOOLS FOR CELLULAR CONCRETE / STIRRERS



### Cellular concrete block trowel

Kielnia do betonu komórkowego, Mörtelkleberkelle - Porenbetonkelle  
Ergonomic, shaped 2k soft handle.  
Steel, notched.  
For mortar distribution.

no.	dimensions	pcs.	ean
1750	115mm	1/5	5 909 220 1750 1
1751	150mm	1/5	5 909 220 1751 1
1752	175mm	1/5	5 909 220 1752 1
1753	200mm	1/5	5 909 220 1753 1
1754	240mm	1/5	5 909 220 1754 1



### Cellular concrete block grooving device

Przyrząd do rowkowania, Rillenkratzer - Schlitzkratzer  
Ergonomic, shaped 2k soft handle.  
Metal.  
For grooving of holes for electric installation in cellular concrete blocks.

no.	dimensions	pcs.	ean
1710	groove width 18mm	1/10	5 909 220 1710 1





## The presentation stirrers



### Mixing Paddle TURBO for plaster mortar, MASTER LINE

Mieszadło Turbo do zapraw gipsowych, MASTER LINE

MASTER LINE TURBO Mischpaddel für Putzmörtel

Steel, galvanized rod with M-14 ending.

For plaster mortar.

no.	dimensions	pcs.	ean
1222	ø 120mm, length: 600mm	1/10	



**Kubala®**  
MASTER LINE



### Mixing Paddle TURBO for cement mortar, MASTER LINE

Mieszadło Turbo do zapraw cementowych, MASTER LINE

MASTER LINE TURBO Mischpaddel für Zementmörtel

Steel, galvanized rod with M-14 ending.

For cement mortar.

no.	dimensions	pcs.	ean
1223	ø 120mm, length: 600mm	1/10	



**Kubala®**  
MASTER LINE



# STIRRERS



## Joint stirrer

Mieszalnik do fug, Fugenrührer

Steel, galvanized.

Round rod  $\varnothing$  8mm.

For stirring of joints, including epoxy joints.

no.	dimensions	pcs.	ean
1232	$\varnothing$ 75mm, length: 300mm	1/10	



## Paint stirrer

Mieszalnik do farb, Farbrührer

Steel, galvanized.

Round rod  $\varnothing$  8mm.

For stirring of paint.

no.	dimensions	pcs.	ean
1201	$\varnothing$ 75mm, length: 500mm	1/10	



## Paint stirrer

Mieszalnik do farb, Farbrührer

Plastic working part PP, notched from the bottom.

Steel rod, galvanized, hexagonal 8mm.

For stirring of paint.

no.	dimensions	pcs.	ean
1203	$\varnothing$ 80mm, length: 500mm	1/10	



## Paint stirrer

Mieszalnik do farb, Farbrührer

Steel, galvanized.

Hexagonal rod 8mm (1225, 1226), 10mm (1227, 1228).

For stirring of paint.

no.	dimensions	pcs.	ean
1225	$\varnothing$ 60mm, length: 400mm	1/10	
1226	$\varnothing$ 80mm, length: 400mm	1/10	
1227	$\varnothing$ 100mm, length: 590mm	1/10	
1228	$\varnothing$ 115mm, length: 590mm	1/10	

### Paint and glue stirrer

Mieszalnik do farb i klejów, Mischer für Farben und Klebern

Working part made by polyamide with fiberglass, notched from the bottom.  
Steel rod, galvanized, hexagonal 10mm (1216).

Steel rod, galvanized, round with M-14 ending 12,5mm (1217)

For stirring of paint and fine grain glue.

no.	dimensions	pcs.	ean
1216	∅ 100mm, length: 500mm	1/10	
1217	∅ 125mm, length: 600mm	1/10	



### Mortal stirrer

Mieszalnik do wylewek, Mörtelrührer

Steel, galvanized.

Hexagonal rod 10mm.

For stirring of paint, plasters and levellings.

Does not aerate the substance.

no.	dimensions	pcs.	ean
1220	∅ 120mm, length: 660mm	1/10	



### Mortar stirrer

Mieszalnik do zapraw, Mörtelrührer

Steel, galvanized.

Hexagonal rod 8mm (1233, 1234).

Round rod ∅ 10mm with M-14 ending (1236).

Round rod ∅ 10mm with SDS ending (1235).

For stirring of mortars and glue.

no	dimensions	pcs.	ean
1233	∅ 80mm, length: 500mm	1/10	
1234	∅ 100mm, length: 500mm	1/10	
1235	∅ 100mm, length: 500mm	1/10	
1236	∅ 120mm, length: 600mm	1/10	



### Mortal stirrer

Mieszalnik do zapraw, Mörtelrührer

Steel, galvanized.

Round rod ∅ 8mm (1207), ∅ 10mm (1208),

∅ 12,5mm with M-14 ending (1213),

∅ 10mm with SDS ending (1230).

For stirring of mortars and glue.

no.	dimensions	pcs.	ean
1207	∅ 80mm, length: 500mm	1/10	
1208	∅ 90mm, length: 500mm	1/10	
1213	∅ 95mm, length: 600mm	1/10	
1230	∅ 90mm, length: 500mm	1/10	



## STIRRERS / CONTAINERS



1211



1209, 1210



1231



### Mortar stirrer "double spiral"

Mieszalnik do zapraw "spirala podwójna", Mörtelrührer  
Steel, galvanized.

Hexagonal rod 8mm (1209, 1210).

Round rod  $\varnothing$  12,5mm with M-14 ending (1211).

Round rod  $\varnothing$  10mm with SDS ending (1231).

For stirring of plasters, mortars and glue.

no.	dimensions	pcs.	ean
1209	$\varnothing$ 70mm, length: 500mm	1/10	
1210	$\varnothing$ 95mm, length: 500mm	1/10	
1211	$\varnothing$ 130mm, length: 600mm	1/10	
1231	$\varnothing$ 95mm, length: 500mm	1/10	



### Mortar stirrer M-14

Mieszalnik do zapraw M-14, Mörtelrührer  
Steel, galvanized.

Round rod  $\varnothing$  12,5mm with M-14 ending.

For stirring of mortars and glue.

no.	dimension	pcs.	ean
1218	$\varnothing$ 135mm, length: 600mm	1/10	



1202, 1204



1206



### Mortar stirrer "spiral"

Mieszalnik do zapraw "spirala", Mörtelrührer  
Steel, galvanized.

Round rod  $\varnothing$  8mm (1202),  $\varnothing$  10mm (1204),

$\varnothing$  12,5mm with M-14 ending (1206).

For stirring of mortars and glue.

no.	dimensions	pcs.	ean
1202	$\varnothing$ 110mm, length: 500mm	1/10	
1204	$\varnothing$ 150mm, length: 600mm	1/10	
1206	$\varnothing$ 140mm, length: 600mm	1/10	



### M14 Extension for mixing paddle

Przedłużka do mieszadeł M-14, Adapter

Extension for mixing paddle with M-14 ending.

For tall users to improve work ergonomoy.

no.	dimensions	pcs.	ean
1212	147mm	1/10	

### Container for gypsum

Pojemnik do gipsu 2l, Gipsbecher  
Made of polyamide with fiberglass  
For gypsum.



no.	dimensions	pcs.	ean
1515	length: 350mm width: 120mm height: 95mm capacity: 2l	1/10	

### Container for gypsum, high

Pojemnik do gipsu, Gipsbecher  
Plastic - rubber.  
For gypsum stirring.



no.	dimensions	ean
1516	capacity: 0,5l 1/20	

### Container for gypsum with stand

Pojemnik do gipsu z podstawką, Gipsbecher  
Plastic - rubber container.  
Stand ø 130mm: plastic PP.  
For gypsum stirring. The plastic part allows to maintain the container's stability during mixing and application of gypsum. Easy to clean.



no.	dimensions	pcs.	ean
1511	capacity: 0,5l	1/20	
1518	capacity: 0,5l with stand	1/10	

### Plastic container

Pojemnik z tworzywa, Gipsbecher  
Plastic PP.  
Handy container with handle for stirring gypsum or paint.



no.	dimensions	pcs.	ean
1514	capacity: 1,5l 1/10		



## CONTAINERS



### Poliamid scoop

Czerpak z poliamidu z włóknem szklanym, Mörtelschöpfer  
Ergonomic, shaped, 2k soft handle.  
Working part made of polyamide with fiberglass.  
Hanging hook on the container.  
For construction works, particularly bricklaying  
and plastering (applying the mortar layer).

no.	dimensions	pcs.	ean
1531	ø 170mm, capacity 0,9l	1/10	



### Plastic scoop

Czerpak z tworzywa, Mörtelschöpfer  
Plastic PP.  
Hanging hook on the container.  
For construction works, particularly bricklaying  
and plastering (applying the mortar layer).

no.	dimensions	pcs.	ean
1530	ø 170mm, capacity 0,9l	1/10	



### Metal scoop

Czerpak metalowy, Mörtelschöpfer  
Ergonomic, shaped handle made of beech wood with the  
FSC certificate. Working part made from metal, galvanized.  
Hanging hook on the container.  
For construction works, particularly bricklaying  
and plastering (applying the mortar layer - spraying).

no.	dimensions	pcs.	ean
1510	ø 170mm, capacity 0,9l	1/10	



### Plastic bucket

Wiadro z tworzywa, Kunststoffeimer  
Plastic PP. Metal handle.  
Litre scale.  
Bucket (1500) with funnel.  
For construction and finishing works.

no.	dimensions	pcs.	ean
1500	capacity: 12l	1/1	
1501	capacity: 12l	1/1	
1502	capacity: 16l	1/1	
1503	capacity: 20l	1/1	

1500



### Plastic construction tub

Kasta budowlana, Kunststoffkasten

Plastic PP.

Litre scale.

For construction and finishing works.

no.	dimensions	pcs.	ean
1517	capacity: 45l	1/1	5 011 792 1517 000
1504	capacity: 65l	1/1	5 011 792 1504 000
1505	capacity: 90l	1/1	5 011 792 1505 000



### Plastic construction container, round

Pojemnik budowlany, Kunststoffbehälter

Plastic PP.

Litre scale.

For construction and finishing works.

no.	dimensions	pcs.	ean
1506	capacity: 45l	1/1	5 011 792 1506 000
1507	capacity: 65l	1/1	5 011 792 1507 000
1508	capacity: 90l	1/1	5 011 792 1508 000



### Glazing bucket 16l

Wiadro glazurnicze, Fliesenleger Waschbox

Plastic PP.

Easy connection of rollers and bucket with patented installation system.

Bucket, grid, wheels (2 pieces) – 1 set. The rollers are sold separately. For tile cleaning after pointing.

no.	dimensions	pcs.	ean
1520	bucket, grid, wheels	1/1	5 011 792 1520 000
1521	rollers for 1520	1/20	5 011 792 1521 000



### Rectangular bucket 20l

Wiadro prostokątne, Fliesenleger Waschbox

Plastic PP.

Easy connection of rollers and bucket with patented installation system.

Bucket, rollers, grid, wheels – sold separately.

For cleaning of tiles after pointing.

no.	dimensions	pcs.	ean
1512	bucket	1/1	5 011 792 1512 000
1513	rollers	1/20	5 011 792 1513 000
1519	grid	1/20	5 011 792 1519 000
1627	wheels (4 pieces)	1/20	5 011 792 1627 000



## CONTAINERS / VENTING SPIKED ROLLER



### Glazing bucket 20l

Wiadro glazurnicze, Fliesenleger Waschbox  
Plastic PP.

Easy connection of rollers and bucket with patented installation system.

Bucket, grid, wheels (2 pieces) – 1 set. The rollers are sold separately. For tile cleaning after pointing.

no.	dimensions	pcs.	ean
1524	bucket, grid, wheels	1/1	
1525	rollers for 1524	1/20	
1529	triple rollers for 1524	1/15	



### Mini glazing set

Komplet glazurniczy mini, Fliesenleger - Set  
Plastic PP.

Easy connection of rollers and bucket with patented installation system.

Bucket volume 16l, grid, wheels (2 pieces), rollers - set. For cleaning of tiles after pointing.

no.	dimensions	pcs.	ean
9907	set	1/1	



### Glazing set

Zestaw glazurniczy, Fliesenleger - Set

The set contains:

1524 - bucket 20l with wheels and grid

1525 - rollers

0387 - float with incised sponge

0325 - pointing float.

no.	dimensions	pcs.	ean
9901	set	1/1	



### Bucket with a lid and a scale made of plastic

Wiadro z tworzywa z pokrywką i podziałką, Kunststoffeimer  
Plastic PP.

Convenient handles on the sides of the bucket, additional metal handle next to the bucket catalog number 1532.

Bucket 1534 - transparent.

Bucket with a lid and a scale.

For construction and finishing works.

no.	dimensions	pcs.	ean
1532	capacity: 20l	1/1	
1533	capacity: 33l	1/1	
1534	capacity: 5l (transparent)	1/1	
1535	capacity: 10l	1/1	

1534



1532

---

### Venting roller

#### Venting roller, Handstachelwalze

Plastic PE.

Roller diameter 75mm, pin height 17mm.

Metal handle, 2K grip soft with a hole for a telescopic stick.

For distribution and venting of self-adjusting levellings, fine- and medium-layered, including epoxy levellings.

no.	dimensions	pcs.	ean
1618	240mm	1/15	



---

### Venting roller

#### Przyrząd do odpowietrzania wylewek, Handstachelwalze

Plastic PE.

Roller diameter 75mm, pin height 17mm.

Metal handle, 2K grip soft with a place for the telescopic stick.

For distribution and venting of self-adjusting levellings, medium - and thick-layered.

no.	dimensions	pcs.	ean
1666	500mm	1/4	
1667	700mm	1/4	



---

### Venting roller

#### Przyrząd do odpowietrzania wylewek, Handstachelwalze

Plastic PE.

Roller diameter 123mm, pin height 40mm.

Metal handle, 2K grip soft with a place for the telescopic stick.

For distribution and venting of self-adjusting levellings, medium - and thick-layered.

no.	dimensions	pcs.	ean
1621	240mm	1/10	



---

### Venting roller

#### Przyrząd do odpowietrzania wylewek, Handstachelwalze

Plastic PE.

Roller diameter 110mm, pin height 40mm.

Metal handle, 2K grip soft with a place for the telescopic stick.

For distribution and venting of self-adjusting levellings, medium - and thick-layered.

no.	dimensions	pcs.	ean
1668	500mm	1/4	
1669	700mm	1/2	



## VENTING SPIKED ROLLER / OTHER TOOLS



### Venting roller

Przyrząd do odpowietrzania wylewek, Handstachelwalze  
Plastic PE.

Roller diameter 85mm, pin height 20mm.

Metal handle, plastic grip with a place for the telescopic stick.

Working part made from one piece which makes it easier to clean.

For distribution and venting of self-adjusting levellings,  
medium-layered.

no.	dimensions	pcs.	ean
1694	240mm	1/15	

### Venting roller

Przyrząd do odpowietrzania wylewek, Handstachelwalze  
Plastic PE.

Roller diameter 85mm, pin height 20mm.

Metal handle, 2K grip soft with a place for the telescopic stick.

For distribution and venting of self-adjusting  
levellings, medium-layered.

no.	dimensions	pcs.	ean
1670	460mm	1/2	

### Venting roller with cover

Przyrząd do odpowietrzania wylewek z osłoną, Handstachelwalze  
Plastic PE, cover: PS.

Roller diameter 85mm, pin height 20mm.

Plastic handle with cover. The cover protects against  
the spattering of the levelling. For distribution  
and venting of self-adjusting levellings, medium-layered.

no.	dimensions	pcs.	ean
1697	240mm	1/10	

### Venting soles

Podeszwy do wylewek, Stachelschuhe  
Plastic PP.

Intended for mounting on shoes.

For walking on self-adjusting levellings,  
during its distribution and venting.

no.	dimensions	pcs.	ean
9910	pin height 25mm	1/4pairs	
9911	pin height 30mm	1/4pairs	



### Pointing support

Podstawka do spoinowania poziom, Vorratsschaufel für Fugenmaterial  
Ergonomic, shaped handle made of beech wood with the FSC certificate. Working part made of metal, galvanized.  
Supporting tool in clinker brick joint pointing.

no.	dimensions	pcs.	ean
1610	150x305x15mm	1/10	5 909799 000000



### Plastic base for mortars

Podstawka do zapraw, Vorratsschaufel für Mörtel  
Plastic working part PS.  
Ergonomic, shaped 2k soft handle.  
Supporting tool in finishing works, particularly at heights.  
The mortar applied on the tool is further applied on the surface.

no.	dimensions	pcs.	ean
9917	330x330mm	1/6	5 909799 000000



### Pointing support, vertical-horizontal

Podstawka do spoinowania, pion-poziom,  
Vorratsschaufel für Fugenmaterial  
Ergonomic, shaped handle made of beech wood with the FSC certificate. Working part made of metal, galvanized.  
Supporting tool in clinker joint pointing. For pointing horizontal and vertical joints.

no.	dimensions	pcs.	ean
1612	280x160x60mm	1/10	5 909799 000000



### Mitre box

Skrzynka uciosowa, Leistenschneidergerät  
Plastic PS.  
For band cutting at an angle of 90° and 45°.

no.	dimensions	pcs.	ean
1644	250x80x50mm	1/10	5 909799 000000
1645	300x115x65mm	1/10	5 909799 000000



## OTHER TOOLS



### Nail with presser

Gwóźdź z dociskiem, Putzhaken

Made of steel, varnished.

Put to use during masonry and plaster work.

no.	dimensions	pcs.	ean
1643	150mm	1/20	



### Metal hole cutter

Wycinak do otworów, Fliesenlochbohrer

Metal. Edge made of cemented carbide.

Adjustment of the cutting: 30-90mm. For cutting holes in ceramic materials up to 4 abrasion resistance class.

For installing in the handle of a manual screwdriver.

no.	dimensions	pcs.	ean
1615	Ø 30-90mm	1/25	



### Knee pad

Nakolanniki, Knieschoner

Made of cellular plastic (rubber), with adjusted rubber fastenings.

One set 2 pieces.

For glazing and paving works.

no.	dimensions	pcs.	ean
1646		1/8 pair	



PE



### Manson's line

Sznurek murarski, Maurerschnur

Polyethylene 9909, 9922, 9923, 9924, 9926.

Polyurethane 9928.

For glazing and paving works.

no.	dimensions	pcs.	ean
9909	white, length 100m, Ø 1mm	1/12	
9922	red, length 100m, Ø 1mm	1/12	
9923	green, length 100m, Ø 1mm	1/12	
9924	red, length 50m, Ø 1,7mm	1/12	
9926	red, length 100m, Ø 1,7mm	1/12	
9928	red, length 50m, Ø 1mm	1/12	

## Measuring tape

Miara zwijana, Taschenbandmaß

no.	dimensions	pcs.	ean
1320	3m	1/12	
1321	5m	1/8	



A wrist strap attached to the item, for easy carrying

Made of ABS&TPR for increased shock absorption

Double side printed blade



Compact housing size

Ergonomic tape locking system

Nylon coated blade improves abrasion resistance



## Folding wooden ruler

Miara składana drewniana, Holzzollstöcke

Beech wood. Side fittings made of hardened steel strip.

Double-sided metric scale. 90° angle locking.

Varnished wood - protects against moisture, sunlight and mechanical wear.

no.	dimensions	pcs.	ean
1325	2 m	1/50	



## Anodised level

Poziomnica anodowana, Anodierte Wasserwaage

Shockproof indicators. Shockproof rubber end caps.

Precision 0,029 = 0,5mm/m. UV resistant.

no.	dimensions	pcs.	ean
1340	30cm	1/5	
1341	40cm	1/5	
1342	50cm	1/5	
1343	60cm	1/5	
1344	80cm	1/5	
1345	100cm	1/5	
1346	120cm	1/5	
1347	150cm	1/5	
1348	200cm	1/5	



## OTHER TOOLS / GLAZING TOOLS



### Red level

#### Poziomnica czerwona, Rote Wasserwaage

Shockproof indicators. Shockproof rubber end caps.

Precision 0,029 = 0,5mm/m. UV resistant.

no.	dimensions	pcs.	ean
1330	30cm	1/5	5 10 0 7 7 9 2 8 3 1 3 3 5 2
1331	40cm	1/5	5 10 0 7 7 9 2 8 3 1 3 3 5 2
1332	50cm	1/5	5 10 0 7 7 9 2 8 3 1 3 3 5 2
1333	60cm	1/5	5 10 0 7 7 9 2 8 3 1 3 3 5 2
1334	80cm	1/5	5 10 0 7 7 9 2 8 3 1 3 3 5 2
1335	100cm	1/5	5 10 0 7 7 9 2 8 3 1 3 3 5 2
1336	120cm	1/5	5 10 0 7 7 9 2 8 3 1 3 3 5 2
1337	150cm	1/5	5 10 0 7 7 9 2 8 3 1 3 3 5 2
1338	200cm	1/5	5 10 0 7 7 9 2 8 3 1 3 3 5 2

### Red level PROFI

#### Poziomnica czerwona PROFI, Rote Wasserwaage PROFI

Shockproof indicators. Shockproof end caps. Lifetime guarantee on vials. Milled bottom (30 - 120cm). UV resistant.

Three indicators (120 - 200cm). Precision 0,029 = 0,5mm/m.

no.	dimensions	pcs.	ean
1350	30cm	1/10	5 10 0 7 7 9 2 8 3 1 3 3 5 2
1351	40cm	1/10	5 10 0 7 7 9 2 8 3 1 3 3 5 2
1352	50cm	1/10	5 10 0 7 7 9 2 8 3 1 3 3 5 2
1353	60cm	1/10	5 10 0 7 7 9 2 8 3 1 3 3 5 2
1354	80cm	1/10	5 10 0 7 7 9 2 8 3 1 3 3 5 2
1355	100cm	1/10	5 10 0 7 7 9 2 8 3 1 3 3 5 2
1356	120cm	1/10	5 10 0 7 7 9 2 8 3 1 3 3 5 2
1357	150cm	1/10	5 10 0 7 7 9 2 8 3 1 3 3 5 2
1358	200cm	1/10	5 10 0 7 7 9 2 8 3 1 3 3 5 2

### Distance piece

#### Rozpierak montażowy, Türspanner, Verstellbar Metal.

Plastic jacking feet, rubber clamping surface.

Width adjustment in the range of 620-960 mm.

For installing window and door frames.

no.	dimensions	pcs.	ean
1629	670-970mm	1/20	5 10 0 7 7 9 2 8 3 1 3 3 5 2

### Universal distance piece

#### Uniwersalny rozpierak montażowy, Türspanner, Verstellbar Metal.

Plastic jacking feet, rubber clamping surface.

Width adjustment in the range of 670-1200 mm.

For installing window and door frames.

no.	dimensions	pcs.	ean
1830	670-1200mm	1/6	5 10 0 7 7 9 2 8 3 1 3 3 5 2



### Distance piece foot

Stopka do ropieraka, Fuß des expanders

Plastic jacking feet, rubber clamping surface.

Can be attached to the lock expander 1629 i 1830.



no.	dimensions	pcs.	ean
1635		1/20	



### Derby float

Łata tynkarska, Trapezförmige Anschlaglatte

Aluminium.

For construction and bricklaying works.



no.	dimensions	pcs.	ean
1304	1000mm	1/1	
1305	1500mm	1/1	
1306	2000mm	1/1	
1307	2500mm	1/1	
1308	1000mm	1/1	
1309	1500mm	1/1	
1310	2000mm	1/1	
1311	2500mm	1/1	

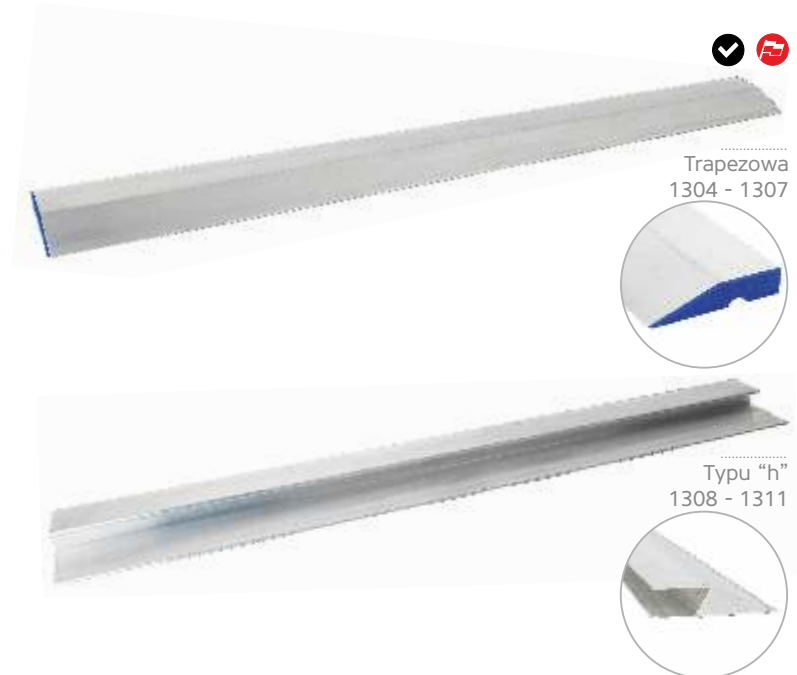

## System for tiles levelling, SMART LEVEL

Smart Level is an innovative system increasing the work efficiency and precision of laying tiles and appropriate ergonomic of particular elements guarantee an ideal final effect.

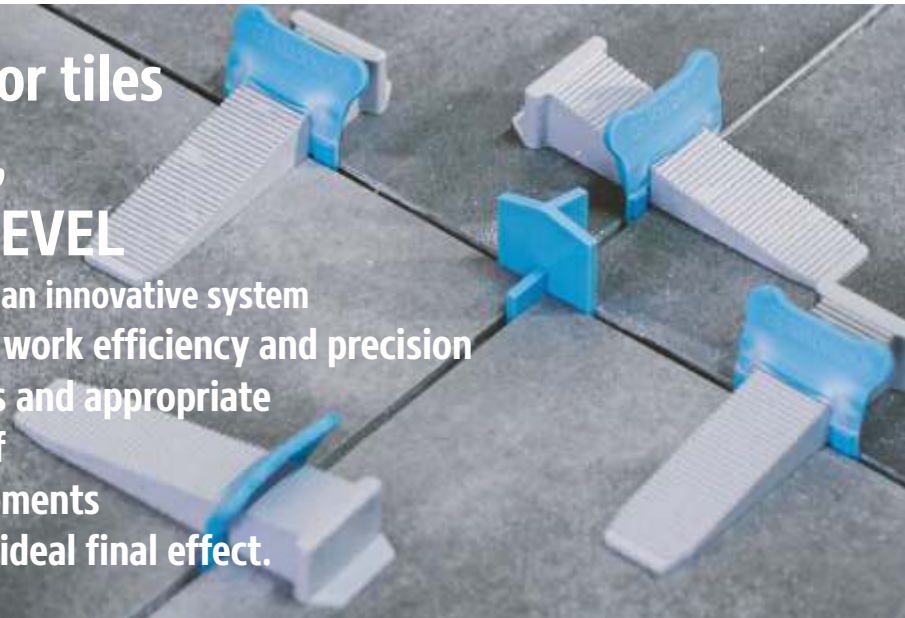

### Magnetic tile holder

Uchwyt magnetyczny do glazury, Magnethalterung für Fliesen

Metal with magnet.

One set 4 pieces.

For mounting on ceramic tiles to form 'inspection windows'.



no.	dimensions	pcs.	ean
1800		1/25	





## GLAZING TOOLS



### Smart Level - Start set

Smart Level zestaw startowy, Smart Level start satz

The set contains:

- clips 1mm - 100psc,
- wedges - 50psc.

Tiles levelling system elements for tile thickness of: 3-16mm.

no.	dimensions	pcs.	ean
1898		1/6	



Tile thickness

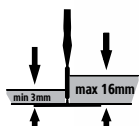

### Smart Level - Clips

Smart Level - klipsy, Smart Level - Clipse

Package includes 100 pieces of spacer clips.

High work efficiency and precision when laying tiles the appropriate construction of the clip makes it easy to remove it after work. Temperature changes have no effect on breaking.

Tiles levelling system elements for tile thickness of: 3-16mm.

no.	dimensions	pcs.	ean
1892	1mm	1/15	
1868	1,5mm	1/15	
1893	2mm	1/15	
1894	3mm	1/15	

1892



1868



1893



1894



Tile thickness

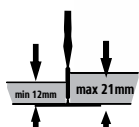

### Smart Level - Clips HIGH

Smart Level - klipsy wysokie, Smart Level - Clipse HOCH

Package includes 100 pieces of spacer clips.

High work efficiency and precision when laying tiles the appropriate construction of the clip makes it easy to remove it after work. Temperature changes have no effect on breaking.

Tiles levelling system elements for tile thickness of: 12-21mm.

no.	dimensions	pcs.	ean
1889	1mm	1/15	



### Smart Level - Wedges

Smart Level - kliny, Smart Level - Keile

Universal wedges fit the clips 1892, 1893, 1894, 1889, 1868.

The high strength of the wedges makes them reusable high work efficiency and precision when laying tiles Tiles levelling system elements for tile thickness of: 3-16mm and 12-21mm.

no.	dimensions	pcs.	ean
1895	bag (50pcs)	1/15	
1896	box (100pcs)	1/6	

### Smart Level- Clips, packaging XXL

Klipsy SMART LEVEL, opakowanie XXL,  
Smart Level - Clipse, verpackung XXL  
Package includes 500 pieces of clips.  
Tiles leveling system, in the range of 3-16mm.

no.	dimensions	pcs.	ean
1817	1mm (pkg. 500psc)	1/1	5 907798118173
1818	1,5mm (pkg. 500psc)	1/1	5 907798118180
1819	2mm (pkg. 500psc)	1/1	5 907798118197
1820	3mm (pkg. 500psc)	1/1	5 907798118203



### Smart Level - Clips + plastic bucket 20l,

Klipsy SMART LEVEL + wiadro z tworzywa 20l,  
Smart Level - Clipse + kunststoffeimer 20l  
Package includes 800 pieces of clips.  
Tiles leveling system, in the range of 3-16mm.

no.	dimensions	pcs.	ean
1885	1mm (pkg. 800psc)	1/1	5 907798118853
1869	1,5mm (pkg. 800psc)	1/1	5 907798118693
1886	2mm (pkg. 800psc)	1/1	5 907798118863
1887	3mm (pkg. 800psc)	1/1	5 907798118870

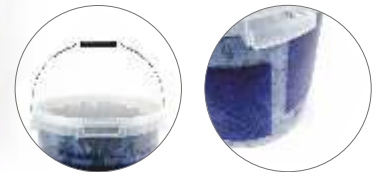

### Smart Level MINI - Clips HIGH

Smart Level MINI - klipsy, Smart Level MINI - Clipse HOCH  
Package includes 100 pieces of clips.  
High work efficiency and precision when laying tiles the appropriate construction of the clip makes it easy to remove it after work. Temperature changes have no effect on breaking.  
Tiles levelling system elements for tile thickness of: 3-14mm.

no.	dimensions	pcs.	ean
1812	1mm (pkg. 100 psc)	1/20	5 907798118123

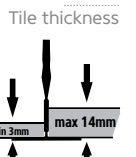

### Smart Level MINI - Wedges

Smart Level MINI - Klíny, Smart Level MINI - Keile  
For Clips SMART LEVEL MINI 1812. High work efficiency and precision when laying tiles the appropriate construction of the clip makes it easy to remove it after work. Temperature changes have no effect on breaking. Tiles leveling system elements for tile thickness of: 3-14mm.  
For clamping the Smart Level MINI system.

no.	dimensions	pcs.	ean
1815	bag (100 psc.)	1/18	5 907798118153



## GLAZING TOOLS



replaceable part is only intended for pliers, under catalog number 1897



1899

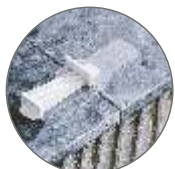

### Replaceable part for pliers - SMART LEVEL MINI

Końcówka do kleszczy - smart level MINI

Ersatzteil für Zangen

Replaceable part for the pliers is only intended for Kubala pliers available under catalog number 1897.

no.	dimensions	pcs.	ean
1816		1/40	

### Pliers

Kleszcze zaciskowe, Klemmzange

For the Smart Level system.

no.	dimensions	pcs.	ean
1897	PP	1/5	
1899	PP + metal	1/5	

### Rubber hammer SMART

Młotek gumowy SMART, Gummihammer

Rubber head, wooden shaft. Construction and tiling works, (removing clips SMART LEVEL).

no.	dimensions	pcs.	ean
1842	300 g	1/6	

### Anti-scratch pads, SMART

Podkładki SMART,, Schutz-Pad für Fliesennivelliersystem

PP material. Transparent pads for the SMART LEVEL system prevent possible scratching of sensitive tiles.

no.	dimensions	pcs.	ean
1884	pkg. (50 pcs.)	1/12	

## Tile spacers SMART

### Krzyżyki dystansowe SMART, Fliesenkreuze SMART

Package includes 100 pieces of tile spacers

SMART tile spacers:

- plastic material : PS
- multiple use, easy to install, stabilize the tile, easy to remove from the joint
- do not lose their dimensions upon removal
- can be applied in corners
- 2 in 1 cross and "T" spacer
- for glazing tiles

no.	dimensions	pcs.	ean
1881	1mm (sack-100pcs)	1/20	5 907798 188120
1882	2mm (sack-100pcs)	1/20	5 907798 188220
1883	3mm (sack-100pcs)	1/18	5 907798 188318

## Tile spacers

### Krzyżyki dystansowe, Fliesenkreuze

Plactic: PS. For tiling.

no.	dimensions	pcs.	ean
1850	1mm (sack-150pcs)	1/50	5 907798 185050
1851	1,5mm(sack-150pcs)	1/50	5 907798 185150
1852	2mm (sack-125pcs)	1/50	5 907798 185250
1853	2,5mm(sack-100pcs)	1/50	5 907798 185350
1854	3mm (sack-90pcs)	1/50	5 907798 185450
1855	3,5mm (sack-90pcs)	1/50	5 907798 185550
1856	4mm (sack-70pcs)	1/50	5 907798 185650
1857	5mm (sack-70pcs)	1/50	5 907798 185750
1858	6mm (sack-50pcs)	1/50	5 907798 185850
1859	8mm (sack-30pcs)	1/50	5 907798 185950
1860	10mm (sack-30pcs)	1/50	5 907798 186050



## Tile spacers with a holder

### Krzyżyki dystansowe z uchwytem, Fliesenkreuze mit Handgriff

Plactic: PS. For tiling.

no.	dimensions	pcs.	ean
1870	1mm (sack-100pcs)	1/50	5 907798 187050
1871	1,5mm(sack-100pcs)	1/50	5 907798 187150
1872	2mm (sack-70pcs)	1/50	5 907798 187250
1873	2,5mm (sack-70pcs)	1/50	5 907798 187350
1874	3mm (sack-70pcs)	1/50	5 907798 187450
1875	3,5mm (sack-70pcs)	1/50	5 907798 187550
1876	4mm (sack-70pcs)	1/50	5 907798 187650
1877	5mm (sack-70pcs)	1/50	5 907798 187750
1878	6mm (sack-50pcs)	1/50	5 907798 187850
1879	8mm (sack-50pcs)	1/50	5 907798 187950
1880	10mm (sack-40pcs)	1/50	5 907798 188050



## Wedges

### Kliny, Fliesenkeile

Plactic: PS. For tiling.

no.	dimensions	pcs.	ean
1890	small(sack-100pcs)	1/200	5 907798 1890200
1891	big (sack-40pcs)	1/200	5 907798 1891200





## ECO LINE



2602  
2603  
2604  
2605  
2606



### Stainless steel trowel

#### Paca nierdzewna, Glättkelle, Edelstahl

Ergonomic, shaped handle made of wood and plastic composite (40% wood, 40% polypropylene, 15% glass, 5% fillers), wooden structure – resistance properties of plastics. Stainless, acid resistant steel: 0,7mm.

For applying of gypsum plasters, mortars and adhesives (2601).  
For distribution of adhesive mortars (2602, 2603, 2604, 2605, 2606).

no.	dimensions	pcs.	ean
2601	130x270mm, smooth	1/10	
2602	130x270mm, notch 4x4	1/10	
2603	130x270mm, notch 6x6	1/10	
2604	130x270mm, notch 8x8	1/10	
2605	130x270mm, notch 10x10	1/10	
2606	130x270mm, notch 12x12	1/10	



2612  
2613  
2614  
2615  
2616



### Stainless steel trowel

#### Paca nierdzewna, Glättkelle, Edelstahl

Ergonomic, shaped handle made of beech wood, impregnated, on jacking feet made by polyamide with fiberglass. Stainless, acid resistant steel: 0,7mm.

For applying gypsum plasters, mortars and adhesives (2611).  
For distribution of adhesive mortars (2612, 2613, 2614, 2615, 2616).

no.	dimensions	pcs.	ean
2611	130x270mm, smooth	1/10	
2612	130x270mm, notch 4x4	1/10	
2613	130x270mm, notch 6x6	1/10	
2614	130x270mm, notch 8x8	1/10	
2615	130x270mm, notch 10x10	1/10	
2616	130x270mm, notch 12x12	1/10	



2622



### Stainless steel trowel

#### Paca nierdzewna, Glättkelle, Edelstahl

Ergonomic, shaped handle made of wood and plastic composite (40% wood, 40% polypropylene, 15% glass, 5% fillers), wooden structure – resistance properties of plastics. Stainless, acid resistant steel: 0,7mm.

For applying of gypsum plasters, mortars and adhesives (2621, 2623).  
For distribution of adhesive mortars and adhesives for net in thermal insulation works (2622).

no.	dimensions	pcs.	ean
2621	130x480mm, smooth	1/4	
2623	130x405mm, smooth	1/4	
2622	130x480mm, notch 10x10	1/4	



2624  
2625



### Stainless steel trowel, smooth

#### Paca nierdzewna, Aufziehglätte, Edelstahl, glatt

Ergonomic, shaped handle made of beech wood, impregnated. Stainless, acid resistant steel: 0,7mm.  
For applying of gypsum plasters, mortars and adhesives.

no.	dimensions	pcs.	ean
2624	130x580mm	1/4	
2625	130x680mm	1/4	



### Stainless steel spatula

#### Szpachla nierdzewna, Gipsspachtel, Edelstahl

Ergonomic, shaped handle made of wood and plastic composite (40% wood, 40% polypropylene, 15% glass, 5% fillers), wooden structure – resistance properties of plastics. Stainless, acid resistant steel: 0,4mm. For construction and finishing works.

no.	dimensions	pcs.	ean
2651	200mm	1/20	5 907798 26517
2652	300mm	1/25	5 907798 26525
2653	450mm	1/20	5 907798 26532



### Stainless steel spatula

#### Szpachla nierdzewna, Gipsspachtel, Edelstahl

Ergonomic, shaped handle made of wood and plastic composite (40% wood, 40% polypropylene, 15% glass, 5% fillers), wooden structure – resistance properties of plastics. Stainless, acid resistant steel: 0,5mm. For construction and finishing works.

no.	dimensions	pcs.	ean
2661	40mm	1/20	5 907798 26617
2662	60mm	1/20	5 907798 26624
2663	80mm	1/20	5 907798 26631
2664	100mm	1/20	5 907798 26648



### Stainless steel spatula

#### Szpachla nierdzewna, Gipsspachtel, Edelstahl

Ergonomic, shaped handle made of wood and plastic composite (40% wood, 40% polypropylene, 15% glass, 5% fillers), wooden structure – resistance properties of plastics. Stainless, acid resistant steel: 0,5mm. For construction and finishing works.

no.	dimensions	pcs.	ean
2671	100mm	1/20	5 907798 26716
2672	120mm	1/20	5 907798 26723
2673	140mm	1/20	5 907798 26730
2674	160mm	1/20	5 907798 26737
2675	180mm	1/20	5 907798 26744
2676	200mm	1/20	5 907798 26751
2677	220mm	1/20	5 907798 26758



### Composite float with sponge

#### Paca z kompozytu z gąbką, Reibebrett, Schwammauflage

Ergonomic, shaped handle made of wood and plastic composite (40% wood, 40% polypropylene, 15% glass, 5% fillers), wooden structure – resistance properties of plastics. Pad dense sponge, thickness: 20mm (2641). Pad sponge with pores, dense, incised, thickness: 30mm (2642). For tile cleaning after pointing.

no.	dimensions	pcs.	ean
2641	140x280mm	1/12	5 907798 26411
2642	140x280mm	1/12	5 907798 26428



2642

2641



2

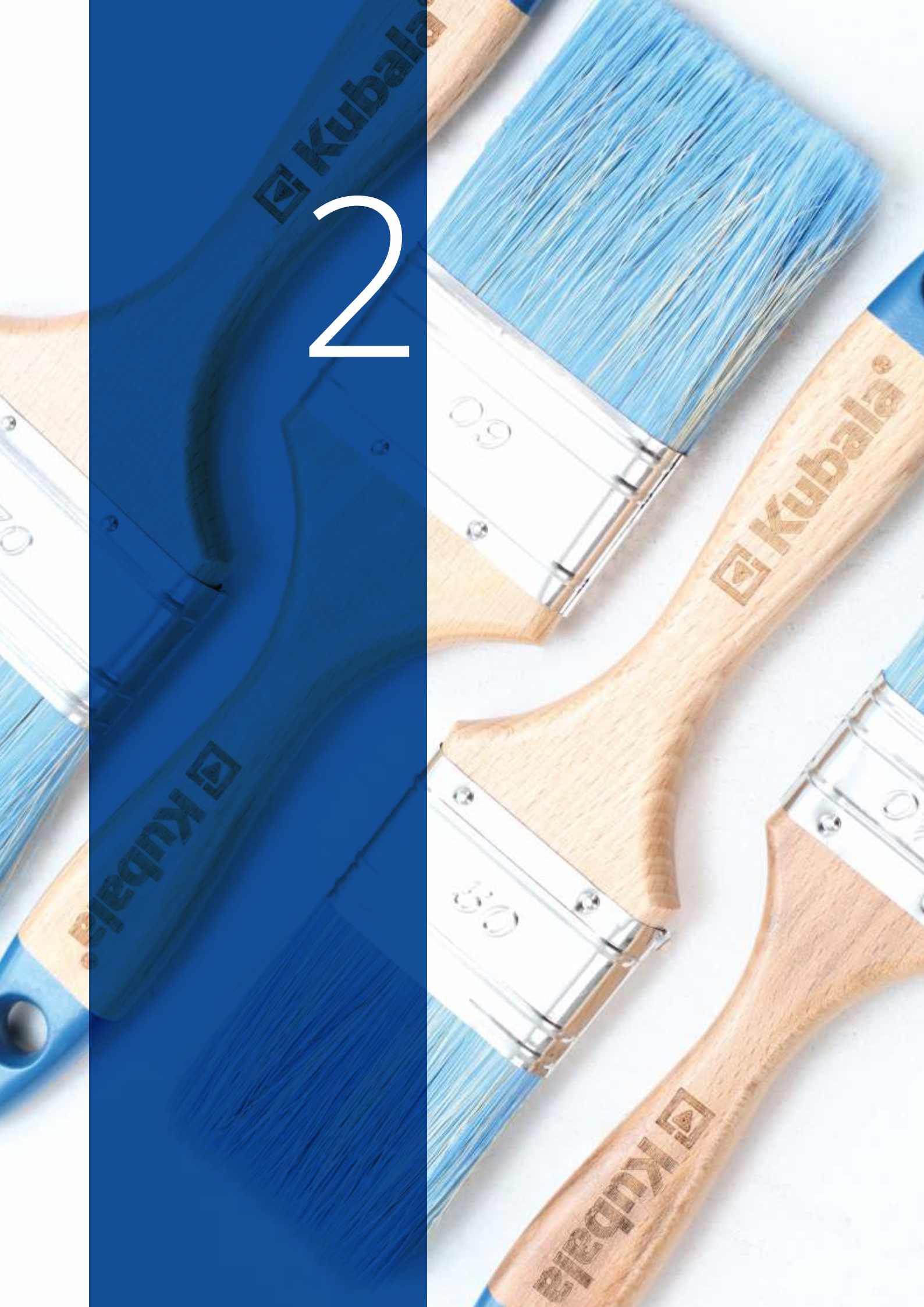

# PAINTING TOOLS





## PAINTBRUSHES



### Flat universal paintbrush, ECO LINE

#### Pędzel płaski uniwersalny Universalpinsel

Ergonomic, shaped handle made of wood and plastic composite (40% wood, 40% polypropylene, 15% glass, 5% fillers), wooden structure – resistance properties of plastics. Working part - composition 30/70, bristle 60% and fibre X-shape. For painting with all kinds of paints.

no.	dimensions	pcs.	ean
4600	20mm	1/12	
4601	30mm	1/12	
4602	40mm	1/12	
4603	50mm	1/12	
4604	60mm	1/12	
4605	70mm	1/12	
4606	80mm	1/12	
4607	100mm	1/12	

### Flat varnish stains paintbrush, ECO LINE

#### Pędzel płaski lakierobejce, Pinsel

Ergonomic, shaped handle made of wood and plastic composite (40% wood, 40% polypropylene, 15% glass, 5% fillers), wooden structure – resistance properties of plastics. Working part - composition 30/70 bristle 60% and brown fibre mini-hollow. Galvanized ferrule. For painting with wood preservation and decoration products.

no.	dimensions	pcs.	ean
4610	20mm	1/12	
4611	30mm	1/12	
4612	40mm	1/12	
4613	50mm	1/12	
4614	60mm	1/12	
4615	70mm	1/12	
4616	80mm	1/12	
4617	100mm	1/12	

### Flat water - thinnable paintbrush, ECO LINE

#### Pędzel płaski wodorozcieńczalne, Pinsel

Ergonomic, shaped handle made of wood and plastic composite (40% wood, 40% polypropylene, 15% glass, 5% fillers), wooden structure – resistance properties of plastics. Working part - composition 20/80, bristle 60% and polyester fibre. Galvanized ferrule.

For painting with paints and water-thinnable lacquers.

no.	dimensions	pcs.	ean
4620	20mm	1/12	
4621	30mm	1/12	
4622	40mm	1/12	
4623	50mm	1/12	
4624	60mm	1/12	
4625	70mm	1/12	
4626	80mm	1/12	
4627	100mm	1/12	

### Decorative paintbrush

#### Pędzel dekoracyjny, Pinsel

Natural handgrip made of beech wood. Working part - composition 50/50 bristle 90% and fibre X-shape. Galvanized ferrule. For venetian clay and decorative paints.

no.	dimensions	pcs.	ean
4561	120mm	1/35	
4562	150mm	1/30	



### English paintbrush

Pędzel angielski, Englisher Pinsel

Ergonomic 2k soft handle.

Working part - composition 50/50 bristle 60% tops and synthetic fibre GOLD. Nickel-plated ferrule.

For painting with all kinds of paints.

no.	dimensions	pcs.	ean
4020	25mm	1/12	5 907798 450200
4021	36mm	1/12	5 907798 450210
4022	50mm	1/12	5 907798 450220
4023	63mm	1/12	5 907798 450230
4024	76mm	1/12	5 907798 450240



### English paintbrush

Pędzel angielski, Englisher Pinsel

Ergonomic 2k soft handle.

Working part - composition 50/50 bristle 60% tops and synthetic fibre GOLD. Nickel-plated ferrule.

For painting with all kinds of paints.

no.	dimensions	pcs.	ean
4025	Ø 14mm	1/12	5 907798 450250
4026	Ø 21mm	1/12	5 907798 450260
4027	Ø 30mm	1/12	5 907798 450270



### Flat universal paintbrush

Pędzel płaski uniwersalny, Universalpinsel

Varnished handgrip made of beech wood.

Working part - composition 50/50 bristle 60% tops and fibre X-shape. Galvanized ferrule.

For painting with all kinds of paints.

no.	dimensions	pcs.	ean
4501	30mm	1/12	5 907798 450010
4502	40mm	1/12	5 907798 450020
4503	50mm	1/12	5 907798 450030
4504	60mm	1/12	5 907798 450040
4505	70mm	1/12	5 907798 450050



### Flat varnish stains paintbrush

Pędzel płaski - lakierobejce, Pinsel

Varnished handgrip made of beech wood.

Working part - composition 50/50 bristle 60% tops and fibre OREL-T. Galvanized ferrule. For painting with wood preservation and decoration products.

no.	dimensions	pcs.	ean
4511	30mm	1/12	5 907798 450110
4512	40mm	1/12	5 907798 450120
4513	50mm	1/12	5 907798 450130
4514	60mm	1/12	5 907798 450140
4515	70mm	1/12	5 907798 450150





## PAINTBRUSHES



### Flat water-thinnable paintbrush

Pędzel płaski - wodorozcieńczalne, Pinsel

Varnished handgrip made of beech wood.

Working part - composition 30/70 bristle 60% tops and synthetic fibre. Galvanized ferrule.

For painting with paints and water-thinnable lacquers.

no.	dimensions	pcs.	ean
4521	30mm	1/12	
4522	40mm	1/12	
4523	50mm	1/12	
4524	60mm	1/12	
4525	70mm	1/12	



### Professional English paintbrush

Pędzel profesjonalny, Pinsel

Natural, ergonomic handgrip made of beech wood.

Working part - composition 50/50

bristle 90% tops and fibre X-shape. Nickel-plated ferrule.

For painting with all kinds of paints and lacquers.

no.	dimensions	pcs.	ean
4531	30mm	1/12	
4532	40mm	1/12	
4533	50mm	1/12	
4534	60mm	1/12	
4535	70mm	1/12	



### Round paintbrush "Extra"

Pędzel okrągły "Extra", Flachpinsel "Extra"

Varnished handgrip made of beech wood.

Working part - composition 50/50 bristle 60% tops and fibre X-shape. Galvanized ferrule.

For painting with all kinds of paints.

no.	dimensions	pcs.	ean
4312	Ø 20mm	1/12	
4314	Ø 30mm	1/12	
4316	Ø 40mm	1/6	
4318	Ø 50mm	1/3	
4320	Ø 60mm	1/3	



### Angular paintbrush "Extra"

Pędzel kaloryferowy, Heizkörperpinsel "Extra"

Varnished handgrip made of beech wood.

Working part - composition 50/50 bristle 60% tops and fibre X-shape. Galvanized ferrule.

For painting with all kinds of paints.

no.	dimensions	pcs.	ean
4326	25x8mm	1/12	
4327	36x8mm	1/12	
4328	50x8mm	1/12	
4329	63x8mm	1/12	

### Wall paintbrush

#### Pędzel ławkowiec, Deckenbürste

Varnished, ergonomic handgrip made of beech wood.

Working part - 100% X-shape.

For painting with water paints, emulsions.

no.	dimensions	pcs.	ean
4541	170x65mm	1/2	5 907798 454125
4542	180x75mm	1/2	5 907798 454225
4543	190x85mm	1/2	5 907798 454325



### Wall-paper paintbrush

#### Pędzel tapetówka, Tapetenbürste

Varnished, ergonomic handgrip made of beech wood.

Working part - composition 50/50 bristle 90% tops and fibre X-shape. Galvanized ferrule.

For painting with all kinds of paints and to wallpaper.

no.	dimensions	pcs.	ean
4551	70mm	1/20	5 907798 455125
4552	100mm	1/12	5 907798 455225
4553	120mm	1/12	5 907798 455325
4554	140mm	1/10	5 907798 455425
4555	150mm	1/10	5 907798 455525
4556	160mm	1/8	5 907798 455625



## PAINT ROLLERS



### Facade roller GOLD

#### Wałek profesjonalny do elewacji GOLD, Fassadenrolle GOLD

Paints a roller sewn with a sponge backing drawn fiber material, thanks to which the hair, even mechanically, cannot be pulled out of the roller. PES plastic.

Hair height: 16mm, wire  $\varnothing$  8mm. Roller for painting external plasters with emulsion, latex and silicate.

no.	dimensions	pcs.	ean
4103	180mm	1/20	
4104	230mm	1/20	



### Facade roller GREEN

#### Wałek profesjonalny do elewacji GREEN, Fassadenrolle GREEN

Made of drawn fiber, therefore the hair, even mechanically, cannot be pulled out of the roller polyamide made of the highest quality drawn fiber.

Hair height: 25mm, wire  $\varnothing$  8mm.

Roller for painting external plasters with emulsion, latex and silicate paints.

no.	dimensions	pcs.	ean
4278	180 mm	1/20	
4279	230 mm	1/20	



### Universal roller "golden thread"

#### Wałek uniwersalny ZŁOTA NIĆ, Universalrolle "Golden Faden"

Roller made by thermofusion method very durable polyamide fiber by using drawn fiber, the hair cannot be torn off the roller.

Hair height: 12mm, wire  $\varnothing$  8mm.

Roller for indoor painting with emulsion, acrylic and latex paints.

no.	dimensions	pcs.	ean
4135	180mm	1/20	
4136	230mm	1/20	



### Universal roller VESTAN

#### Wałek uniwersalny VESTAN,

#### Universalrolle VESTAN

The roller is made by thermofusion, which consists in permanent welding of the textile material with the roller core the high quality of the product is ensured by the use of thermofusion.

Made of polyester. Hair height: 18mm, wire  $\varnothing$  8mm.

roller for painting with emulsion and latex paints and for priming walls, glass fibers, polyester resins, bituminous masses.

no.	dimensions	pcs.	ean
4111	180 mm	1/20	
4112	230mm	1/20	

### Standard roller DUOKOLOR

#### Wałek do wnętrz DUOKOLOR, Mallerolle für Innenräume DUOKOLOR

The roller is made by thermofusion, which consists in permanent welding of the textile material with the roller core. The high quality of the product is ensured by the use of thermofusion. Very efficient polyester fiber. Hair height: 12mm, wire ø 8mm. Roller for painting with emulsion, acrylic and latex paints.

no.	dimensions	pcs.	ean
4123	180 mm	1/20	
4124	230 mm	1/20	



### Varnishing roller NATURAL VELOUR

#### Wałek do lakierów i farb agresywnych VELUR NATURALNY, Mallerolle für aggressive Farben und Lacke NATURAL VELOUR

The roller is made by thermofusion, which consists in permanent welding of the textile material with the roller core. Thermofusion guarantees high product quality. Natural wool 100%. Hair height: 5mm, wire ø 8mm. Roller for painting with aggressive paints, water-based varnishes, solvent-based varnishes and thick varnishes.

no.	dimensions	pcs.	ean
4131	180mm	1/20	
4132	230mm	1/20	



### Varnishing roller MIKROFIBRE 9mm

#### Wałek do farb lateksowych i bejc MICROFIBRA 9mm, Malerrolle für Latexfarben MICROFIBRE

The roller is made by thermofusion, which consists in permanent welding of the textile material with the roller core. The high quality of the product is ensured by the use of thermofusion. High quality microfiber. Hair height: 9mm, wire ø 8mm. Roller for painting with latex, stain and varnish paints.

no.	dimensions	pcs.	ean
4272	180 mm	1/20	
4273	230 mm	1/20	



### Varnishing roller Microfibre 12mm

#### Wałek do farb lateksowych i bejc MICROFIBRA 12mm, Malerrolle für Latexfarben MICROFIBRE 12mm

The roller is made by thermofusion, which consists in permanent welding of the textile material with the roller core. High quality microfiber. Hair height: 12mm, wire ø 8mm. Roller for painting with latex, stain and varnish paints.

no.	dimensions	pcs.	ean
4119	180mm	1/20	
4120	230mm	1/20	



## PAINT ROLLERS



### Varnishing roller MIKROFIBRE 16mm

Wałek do farb lateksowych i bejc MICROFIBRE 16mm,  
Malerrolle für Latexfarben MICROFIBRE 16mm

The roller is made by thermofusion, which consists in permanent welding of the textile material with the roller core.  
The high quality of the product is ensured by the use of thermofusion.  
High quality microfiber. Hair height: 16mm, wire  $\varnothing$  8mm.  
Roller for painting with latex, stain and varnish paints.

no.	dimensions	pcs.	ean
4270	180 mm	1/20	
4271	230 mm	1/20	



### Varnishing roller POLYAMID

Wałek do lakierów na bazie wody POLYAMID,  
Rolle für wasserlösliche Lacke POLYAMID

The roller is made by thermofusion, which consists in permanent welding of the textile material with the roller core the high quality of the product is ensured by the use of thermofusion.  
Very durable polyamide fiber, resistant to solvents.  
Hair height: 6mm, wire  $\varnothing$  8mm. Roller for painting with oil paints, varnishes, epoxy paints and priming epoxy and polyester resins.

no.	dimensions	pcs.	ean
4115	180 mm	1/20	
4116	230mm	1/20	



### Roller for gel primers

Wałek do gruntów żelowych, Walze für Gel-Primer

Made using the thermofusion method, ensures high quality of the product. The sides of the shaft are chamfered by machine.  
Made of polyester. Hair height: 25mm, wire  $\varnothing$  8mm.  
Roller intended for application gel primers.  
Application on smooth surfaces, medium-smooth and porous surfaces can be obtained uniform structure of the primed surface.

no.	dimensions	pcs.	ean
4134	230 mm	1/20	



### Universal roller gold

Wałek Uniwersalny midi ZŁOTA NIĆ, Midi-Universalrolle "Golden Faden"

The roller is made by thermofusion, which consists in permanent welding of the textile material with the roller core.  
Thermofusion guarantees high product quality. Polyamide.  
Hair height: 12mm, wire  $\varnothing$  6mm.  
Roller for indoor painting with emulsion, acrylic and latex paints.

no.	dimensions	pcs.	ean
4142	100 mm	1/50	
4143	150 mm	1/50	



### Universal roller gold

Wałek mini uniwersalny ZŁOTA NIĆ, Mini-Mallerrolle Universal "Gelb Faden"

Roller produced with thermofusion.

Thermofusion guarantees high product quality. Durable polyamide fiber.

By using drawn fiber, hair cannot be pulled from roller.

Polyamide. Hair height: 12mm, wire ø 6mm.

Roller for indoor painting with emulsion, acrylic and latex paints.

no.	dimensions	pcs.	ean
4160	60mm, 2-psc.	1/20	
4161	100mm, 2-psc.	1/20	



### Varnishing roller Velour-medium

Wałek do lakierów i farb agresywnych, Mallerrolle für Farben und Lacke

The roller is made by thermofusion, which consists in permanent

welding of the textile material with the roller core. Thermofusion

guarantees high product quality. Hair height: 4mm, wire ø 6mm.

Natural wool 100%. Roller for painting with aggressive paints,

water-based varnishes, solvent-based varnishes and thick varnishes.

no.	dimensions	pcs.	ean
4154	100mm	1/50	
4155	150mm	1/50	



### Varnishing roller mini VELOUR

Wałek do lakierów i farb agresywnych mini "Velur kremowy",

Mini-Mallerrolle für Farben und Lacke

The roller is made by thermofusion, which consists in permanent

welding of the textile material with the roller core. Thermofusion

guarantees high product quality. Natural wool 100%.

Hair height: 4mm, wire ø 6mm. Roller for painting with aggressive

paints, water-based varnishes, solvent-based varnishes and thick paints.

no.	dimensions	pcs.	ean
4166	50mm, 2-psc.	1/20	
4167	100mm, 2-psc.	1/20	



### Water-based varnish roller mini POLYAMID

Wałek do lakierów na bazie wody mini POLYAMID, Malerrolle für Latexfarben

The roller is made by thermofusion, which consists in permanent

welding of the textile material with the roller core. Thermofusion

guarantees high product quality. Polyamide.

Hair height: 12mm, wire ø 6mm.

Roller for painting with silicone and silicate paints and water-based varnishes.

no.	dimensions	pcs.	ean
4277	100 mm, 2-pak	1/20	



## PAINT ROLLERS / PAINT ACCESSORIES



### Roller recharge white foam

Wałek gąbkowy, Ersatzroller, weißer Schwamm  
White foam, foam diameter 35mm, wire  $\varnothing$  6mm.  
For general application on smooth surfaces,  
for varnish not based on cellulose.

no.	dimensions	pcs.	ean
4171	100 mm, 2-pak	1/20	



### "Flock" roller

Wałek "Flock", Ersatzteile "Flock"  
Covered with flock material, which prevents the creation  
of bubbles during painting. Roller rounded from both sides.  
Roller diameter: 35mm. Wire  $\varnothing$  6mm.  
To be used for acrylic paint and others,  
as well as varnish not based on cellulose.

no.	dimensions	pcs.	ean
4183	100 mm, 2-pak	1/20	



### Varnishing roller midi MICROFIBRE 9mm

Wałek do farb lateksowych i bejc midi MIKROFIBRA,  
Midi malerrolle für Latexfarben MICROFIBRE  
The roller is made by thermofusion, which consists in  
permanent welding of the textile material with the roller core.  
High quality microfiber. Hair height: 9mm, wire  $\varnothing$  6mm.  
Roller for painting with latex, stain and varnish paints.

no.	dimensions	pcs.	ean
4274	100 mm	1/50	
4275	150 mm	1/50	



### Varnishing roller mini MICROFIBRE 9mm

Wałek do farb lateksowych i bejc mini MIKROFIBRA  
Mini malerrolle für Latexfarben MICROFIBRE  
The roller is made by thermofusion, which consists in  
permanent welding of the textile material with the roller core.  
High quality microfiber. Hair height: 9mm, wire  $\varnothing$  6mm.  
Roller for painting with latex, stain and varnish paints.

no.	dimensions	pcs.	ean
4280	50 mm, 2-pak	1/20	
4276	100 mm, 2-pak	1/20	
4281	150 mm, 2-pak	1/20	

### Corner roller

Wałek do narożników, Eckrolle

Polyacryl.

Hair height: 14mm. Wire  $\varnothing$  6mm.

Roller for painting with wall, facade and acrylic paints.

no.	dimensions	pcs.	ean
4244	$\varnothing$ 100mm	1/10	



### Paint stirrer

Mieszadło do farb, Farbrührer

Plastic PP.

For paint cans opening, paint mixing and paint roller cleaning.

no.	dimensions	pcs.	ean
0710	280mm	1set(40pcs.)/5	



### Roller handle

Uchwyt do wałka, Griff für Malerrolle

Plastic PP handle.

Wire  $\varnothing$  6mm or  $\varnothing$  8mm.

For any rollers depending on its width.

no.	dimensions	pcs.	ean
4190	50-70mm, $\varnothing$ 6mm	1/20	
4191	100-150mm, $\varnothing$ 6mm	1/20	
4194	180mm, $\varnothing$ 8mm	1/50	
4195	230mm, $\varnothing$ 8mm	1/50	



### Roller handle

Uchwyt do wałka, Griff für Malerrolle

Ergonomic, shaped 2k soft handle.

Wire  $\varnothing$  6mm or  $\varnothing$  8mm.

For any rollers depending on its width.

no.	dimensions	pcs.	ean
4196	180mm, $\varnothing$ 8mm	1/50	
4197	230mm, $\varnothing$ 8mm	1/50	



## PAINT ACCESSORIES



PP



### Paint tray

Kuweta, Farbschale

Plastic PP.

For any kind of paint.

Tray size depends on the roller size.

no.	dimensions	pcs.	ean
4201	350x330mm	1/50	5 07798 42010
4202	320x260mm	1/10	5 07798 42020
4203	260x230mm	1/10	5 07798 42030
4204	240x150mm	1/20	5 07798 42040
4205	190x110mm	1/10	5 07798 42050



### Paint tray recharge

Zapasy do kuwet, Ersatzteile für Farbschale

The paint tray recharge help to keep the tray clean and use it for many paint colours.

Size of the recharge part depends on the tray size.

no.	dimensions	pcs.	ean
4210	350x330mm	1/100	5 07798 42100
4211	320x260mm	1/100	5 07798 42110
4212	260x230mm	1/100	5 07798 42120
4213	240x150mm	1/100	5 07798 42130
4214	190x110mm	1/100	5 07798 42140



PP



### Grid

Kratka, Gitter

Plastic PP.

Grid for extracting excess paint form roller.

Grid size depends on the roller width.

Grid has two handles to hang on the bucket.

no.	dimensions	pcs.	ean
4220	210x250mm	1/20	5 07798 42200
4221	260x280mm	1/20	5 07798 42210



### Telescopic stick

Teleskopstange, Kij teleskopowy

Material – powder coated metal. Comprised of two sections.

The stick features special reduction adapters

which enable easy attachment of painting roller and venting rollers handles.

no.	dimensions	pcs.	ean
4198	2m	1/20	5 07798 41980
4199	3m	1/12	5 07798 41990

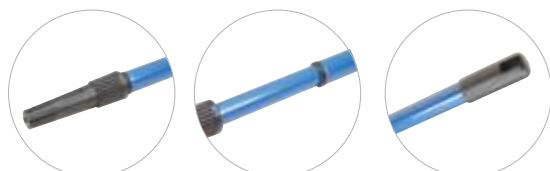

### Plastic bucket 14l

Kunststoffeimer, Wiadro malarskie

Plastic PP, metal handle.

Litre scale.

For painting work.

no.	dimensions	pcs.	ean
4200	14l	1/1	5903010000000



### Device for cleaning paint rollers and plaster rollers CLEANER

Przyrząd do czyszczenia wałków malarskich i wałków do gładzi CZYŚCIK, Rollenreinigungswerkzeug

Device for cleaning all kinds of rollers, including plaster rollers a tool dedicated to drills and screwdrivers. Galvanized steel. Round bar  $\varnothing$  8 mm. The mechanical way of cleaning the roller in a bucket is more effective and faster than washing the roller under running water. Registered design.

no.	dimensions	pcs.	ean
4000	84x550 mm	1/8	5903010000000



### Device for cleaning paint rollers and plaster rollers CLEANER + Varnishing roller MICROFIBRE

Przyrząd do czyszczenia wałków malarskich i wałków do gładzi CZYŚCIK + wałek do farb lateksowych i bejc MIKROFIBRA,, Rollenreinigungswerkzeug + Malerrolle für Latexfarben MICROFIBRE

Device for cleaning all kinds of rollers, including plaster rollers a tool dedicated to drills and screwdrivers. Galvanized steel. Round bar  $\varnothing$  8 mm. The mechanical way of cleaning the roller in a bucket is more effective and faster than washing the roller under running water. Registered design.

The roller is made by thermofusion, which consists in permanent welding of the textile material with the roller core. The high quality of the product is ensured by the use of thermofusion. High quality microfiber.

Hair height: 12mm, wire  $\varnothing$  8mm. Roller for painting with latex, stain and varnish paints.

no.	dimensions	pcs.	ean
5504	84x550 mm + roller 230 mm	1/8	5903010000000





## PROTECTIVE FOIL



### Protective foil STANDARD, thin

Folia ochronna STANDARD, cienka, transparentna, Abdeckfolie  
HDPE, grammage 75g.

no.	dimensions	pcs.	ean
4701	4x5m=20m <sup>2</sup>	1/50	



### Protective foil STANDARD, medium

Folia ochronna STANDARD, średnia, Abdeckfolie  
LDPE, grammage 240g.

no.	dimensions	pcs.	ean
4702	4x5m=20m <sup>2</sup>	1/30	



### Protective foil SUPER STRONG, thick

Folia ochronna SUPER STRONG, gruba, Abdeckfolie  
LDPE, grammage 600g.

no.	dimensions	pcs.	ean
4703	4x5m=20m <sup>2</sup>	1/12	



### Protective foil SUPER STRONG, thick

Folia ochronna SUPER STRONG, gruba, transparentna, Abdeckfolie  
LDPE, grammage 500g.

no.	dimensions	pcs.	ean
4704	4x5m=20m <sup>2</sup>	1/15	



3

Kubala®

**Kubala®**  
PROFESYONALNY SYSTEM PODKŁADKI  
**SMART LEVEL**  
System podkładowy płyt  
• The leveling system  
• Wzmacniający system do płyt  
• Wytrzymały system podkładowy  
• System "Smart Level"  
• System do poziomowania płyt  
• System do poziomowania płyt

Kubala®  
SMART LEVEL



**PODKŁADKI SMART  
ANTI-SCRATCH PADS**  
1684 | 50 szt. / paczka  
MADE IN POLAND  
SMART MATERIAL



# EXPOSITION SYSTEMS





 Kubala®

 Kubala®





 Kubala®

 Kubala®



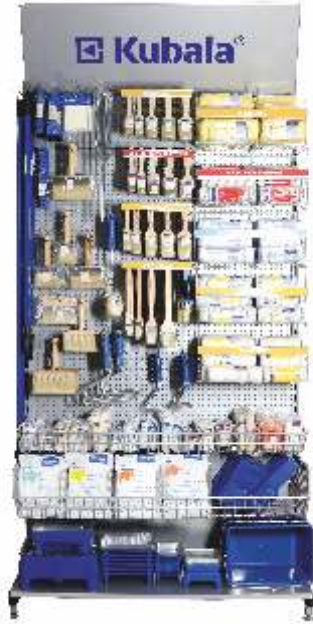









# Akademia

DOBREJ PRAKTYKI

 Kubala®



The Kubala MasterClass is our proprietary project aimed directly at Contractors to support and facilitate their professional development. The Academy conducts training courses that encourage them not to fall into a rut, to look for new solutions and improve their qualifications. We are a manufacturer of construction hand tools, and our offer is constantly expanding. So, it is important to us that Contractors understand why and when it is worth using particular tools. How to increase the work's efficiency and improve the quality of work with the right choice of tool. Our instructors are practitioners who teach how to use the novelties appearing on the market and how to select tools to get spectacular results. The opportunity for personal contact with Contractors during training sessions is also very valuable to us. Thanks to these meetings, we can quickly respond to the needs of Contractors and introduce the best solutions for them. As part of the Kubala MasterClass project, we cooperate with and support finishing industry associations and vocational schools. We believe it is worth expanding knowledge and exchanging experiences, especially in a world that is changing so quickly, and knowledge is outdated by rapidly evolving technology.





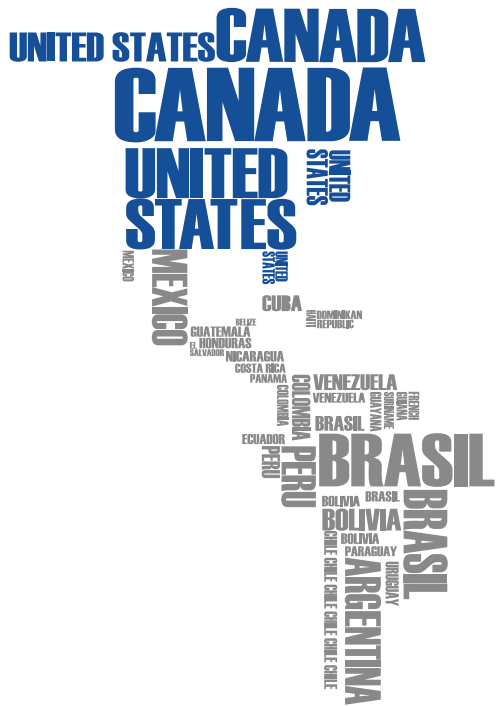



 **Kubala<sup>®</sup>**

BUILDING TOOLS MANUFACTURER

 [facebook.com/kubalapl](https://facebook.com/kubalapl)

[www.kubala.com](http://www.kubala.com)



Follow us

 [instagram.com/kubala.tools](https://instagram.com/kubala.tools)

**#kubalatools**